

**LED
LIGHTING
GREEN
BOOK
.19**

~~LOGICA~~

**KLIK_KLAK
MAGNETIC
SYSTEM**
P 4

**STREAMLIGHT
SYSTEM**
P 12

CLARA
P 18

TRACK_COVER
P 20

**LINE_DEEP
INCASSO**
P 24

OCCHIOLED
P 26

**HYPER_DICRO
+ BLITZ**
P 28

OUTDOOR
P 30



PROIETTORI
P 7

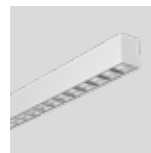

STREAMLIGHT_
SYSTEM
P 15



CLARA
P 19



TRACK_COVER
P 22



LINE_DEEP
INCASSO
P 25



OCCHIOLED
P 27

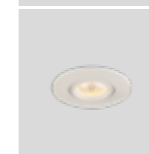

OCCHIOLED
REGOLABILE
P 27



HYPER_DICRO
P 29



BLITZ
P 29



MOONLIGHT
PALO
P 33



MOONLIGHT
PARETE
P 33



FOS PALO
P 35



FOS PARETE
P 35

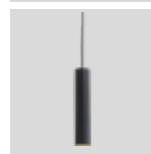

SOSPENSIONE
P 8

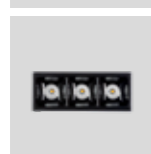

PUNTIFORMI
P 8



PUNTIFORMI
ORIENTABILI
P 9



LUCE DIFFUSA
P 9

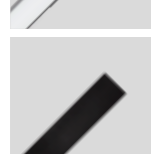

PROFILI
MAGNETICI
P 10

ONE4ALL
P 36



ONE4ALL
P 36

QUICK & EASY

SISTEMA MAGNETICO/ MAGNETIC SYSTEM

Un sistema completo che si inserisce in maniera minimale negli spazi abitativi e commerciali rendendo la luce parte integrante del design. Declinabile in diverse tipologie di installazione (incasso a raso, a soffitto ed a sospensione) con la possibile aggiunta di curve, si adatta a qualsiasi superficie. L'inserimento dei corpi illuminanti a 24V con fissaggio magnetico completa il sistema, spaziando da un orientabile 15W a sorgenti puntiformi fisse e orientabili fino a profili con SMD per luce diffusa.



It's a complete range which discreetly steps into residential or commercial environments making light a fundamental part of the whole design project. The system can be applied for several applications (recessed, ceiling mounted or suspended) and thanks to its corner accessories it's suitable for any kind of surface. The availability of several 24V lighting fittings with magnetic fastening completes the system. The lighting fittings which can be installed include: a 15W spot-light, some fixed or adjustable lighting dots and some profiles mounting SMD Led for general lighting.



Apparecchi LED integrato bassa tensione per binario magnetico. Corpo in alluminio verniciato.

Low voltage built-in LED fittings for magnetic tracks. Painted aluminium body.



CODE	FINISHING	BEAM	WATT	KELVIN	LED	LUMEN	CRI	PF	APPLICATION
41111	Nero/Black	36°	10W	3000K	CREE	870	98	>0,5	Magnetic track
41112	Bianco/White	36°	10W	3000K	CREE	870	98	>0,5	Magnetic track

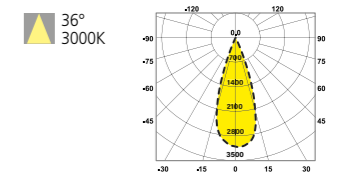
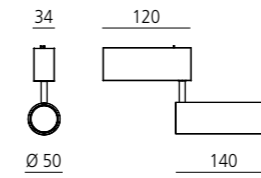

CODE	FINISHING	BEAM	WATT	KELVIN	LED	LUMEN	CRI	PF	APPLICATION
41175	Bianco/White	36°	8W	3000K	CREE	450	98	>0,5	Magnetic track
41176	Nero/Black	36°	8W	3000K	CREE	450	98	>0,5	Magnetic track

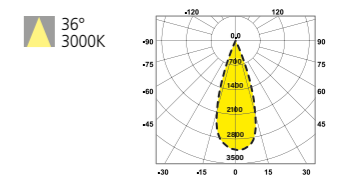
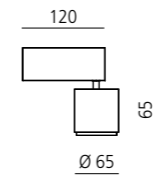

CODE	FINISHING	BEAM	WATT	KELVIN	LED	LUMEN	CRI	PF	APPLICATION
41177	Bianco/White	36°	15W	3000K	CREE	850	98	>0,5	Magnetic track
41178	Nero/Black	36°	15W	3000K	CREE	850	98	>0,5	Magnetic track

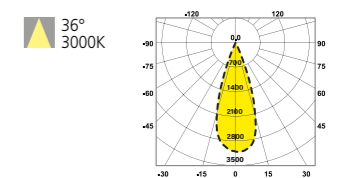
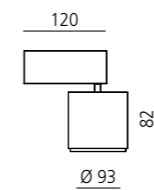



CODE	FINISHING	BEAM	WATT	KELVIN	LED	LUMEN	CRI	PF	APPLICATION
41173	Bianco/White	36°	10W	3000K	CREE	870	98	>0,5	Magnetic track
41174	Nero/Black	36°	10W	3000K	CREE	870	98	>0,5	Magnetic track

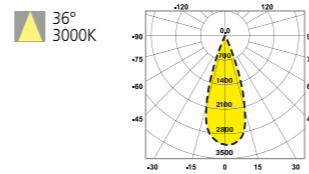

CODE	FINISHING	BEAM	WATT	KELVIN	LED	LUMEN	CRI	PF	APPLICATION
41125	Nero/Black	34°	3x1W	3000K	OSRAM	255	>90	>0,5	Magnetic track
41128	Bianco/White	34°	3x1W	3000K	OSRAM	255	>90	>0,5	Magnetic track
41126	Nero/Black	34°	6x1W	3000K	OSRAM	510	>90	>0,5	Magnetic track
41129	Bianco/White	34°	6x1W	3000K	OSRAM	510	>90	>0,5	Magnetic track
41127	Nero/Black	34°	12x1W	3000K	OSRAM	1020	>90	>0,5	Magnetic track
41130	Bianco/White	34°	12x1W	3000K	OSRAM	1020	>90	>0,5	Magnetic track

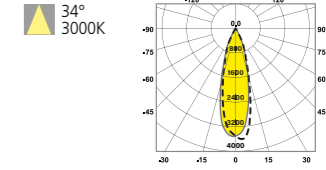
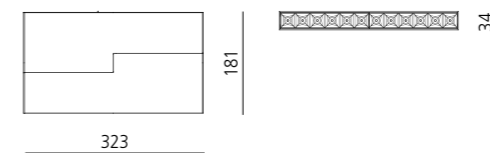
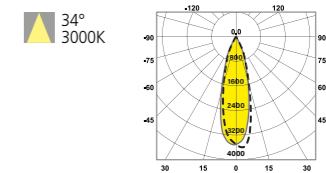
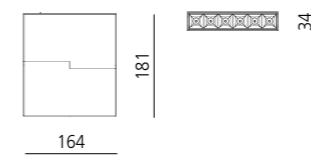
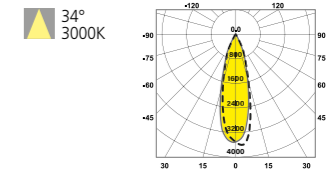
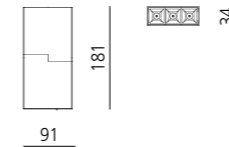

CODE	FINISHING	BEAM	WATT	KELVIN	LED	LUMEN	CRI	PF	APPLICATION
41119	Nero/Black	34°	3x1W	3000K	OSRAM	255	>90	>0,5	Magnetic track
41122	Bianco/White	34°	3x1W	3000K	OSRAM	255	>90	>0,5	Magnetic track
41120	Nero/Black	34°	6x1W	3000K	OSRAM	510	>90	>0,5	Magnetic track
41123	Bianco/White	34°	6x1W	3000K	OSRAM	510	>90	>0,5	Magnetic track
41121	Nero/Black	34°	12x1W	3000K	OSRAM	1020	>90	>0,5	Magnetic track
41124	Bianco/White	34°	12x1W	3000K	OSRAM	1020	>90	>0,5	Magnetic track

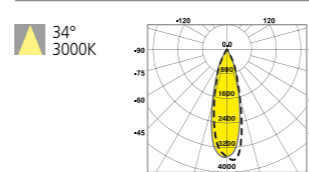
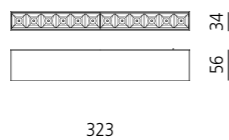
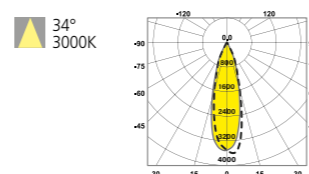
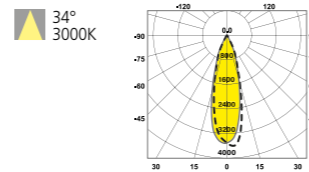
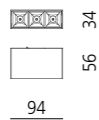

CODE	FINISHING	BEAM	WATT	KELVIN	LED	LUMEN	CRI	PF	APPLICATION
41113	Nero/Black	90°	10W	3000K	OSRAM	850	>90	>0,5	Magnetic track
41116	Bianco/White	90°	10W	3000K	OSRAM	850	>90	>0,5	Magnetic track
41114	Nero/Black	90°	20W	3000K	OSRAM	1700	>90	>0,5	Magnetic track
41117	Bianco/White	90°	20W	3000K	OSRAM	1700	>90	>0,5	Magnetic track
41115	Nero/Black	90°	30W	3000K	OSRAM	2550	>90	>0,5	Magnetic track
41118	Bianco/White	90°	30W	3000K	OSRAM	2550	>90	>0,5	Magnetic track

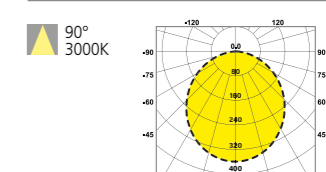
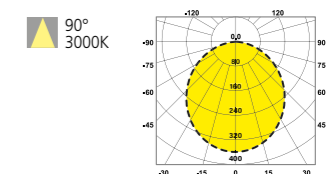
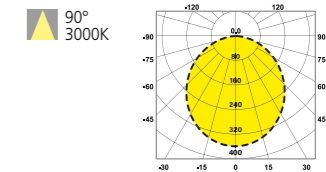
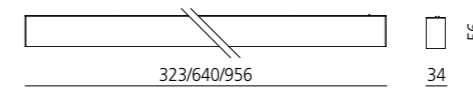

CODE	FINISHING	DESCRIPTION	KG
41109	Nero/Black	Struttura 1mt in alluminio estruso con testate/1mt extruded aluminium profile with end-caps	1,5
41110	Bianco/White	Struttura 1mt in alluminio estruso con testate/1mt extruded aluminium profile with end-caps	1,5
41144	Nero/Black	Struttura 2mt in alluminio estruso con testate/2mt extruded aluminium profile with end-caps	3,0
41145	Bianco/White	Struttura 2mt in alluminio estruso con testate/2mt extruded aluminium profile with end-caps	3,0

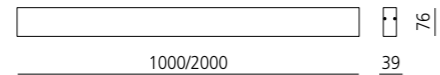

CODE	FINISHING	DESCRIPTION
41142	Nero/Black	Congiunzione elettrica con spinotti / Linear 65mm electric connection with relative 3-pins connector
41143	Bianco/White	Congiunzione elettrica con spinotti / Linear 65mm electric connection with relative 3-pins connector



CODE	FINISHING	DESCRIPTION
41146	Nero/Black	Copertura per rasatura 1 mt/1 mt mask for plasterboard thinning

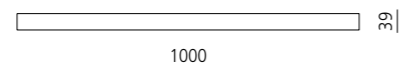

CODE	FINISHING	DESCRIPTION
41131	Nero/Black	Kit staffe incasso (2 pz)/Brackets for recessed installation (2 pcs)

CODE	FINISHING	DESCRIPTION
41136	Nero/Black	Angolo 90° con spinotti e staffe connessione / 90° corner with relative 3-pins connectors and connection plates
41137	Bianco/White	Angolo 90° con spinotti e staffe connessione / 90° corner with relative 3-pins connectors and connection plates



CODE	FINISHING	DESCRIPTION
41132	Nero/Black	Sospensione 2mt (1 pz)/Suspension 2mt (1 pc)
41132/A	Nero/Black	Sospensione con cavo alimentazione 2mt (1 pz)/Suspension 2mt with electrical wire (1 pc)
41133	Bianco/White	Sospensione 2mt (1 pz)/Suspension 2mt (1 pc)
41133/A	Bianco/White	Sospensione con cavo alimentazione 2mt (1 pz)/Suspension 2mt with electrical wire (1 pc)

CODE	FINISHING	DESCRIPTION
41138	Nero/Black	Angolo 90° esterno con spinotti e staffe connessione / Outer 90° corner with relative 3-pins connectors and connection plates
41139	Bianco/White	Angolo 90° esterno con spinotti e staffe connessione / Outer 90° corner with relative 3-pins connectors and connection plates



CODE	FINISHING	DESCRIPTION
41134	Nero/Black	Staffa connessione (1 pz)/Linear connection plate (1 pc)
41135	Bianco/White	Staffa connessione (1 pz)/Linear connection plate (1 pc)

CODE	FINISHING	DESCRIPTION
41140	Nero/Black	Angolo 90° interno con spinotti e staffe connessione / Inner 90° corner with relative 3-pins connectors and connection plates
41141	Bianco/White	Angolo 90° interno con spinotti e staffe connessione / Inner 90° corner with relative 3-pins connectors and connection plates



DRIVERS

CODE	DIMENSIONS	DESCRIPTION
22015	99x82x30mm	driver 50W 24V DC
22016	129x97x30mm	driver 100W 24V DC
22025	160x95x30mm	driver 150W 24V DC
22017	215x115x30mm	driver 200W 24V DC

THE RIGHT LIGHT

STREAMLIGHT_SYSTEM

Sistema modulare LED integrato. Una soluzione ottimale per illuminare uffici direzionali e operativi. Il sistema monta ottiche progettate per ridurre lo sforzo visivo e creare un benessere indispensabile nell'ambiente di lavoro. La luce indiretta contribuisce ad accentuare l'effetto benessere ammorbidendo l'ambiente circostante. La modularità degli apparecchi integrata con gli accessori permette una progettazione personalizzata per ogni ambiente.



LED modular system. A perfect lighting solution for open space working stations or management offices. The system is equipped with optical reflectors purposely designed to reduce visual strain and create that comfort which is indispensable in working areas. The indirect lighting contributes to enhance the comfort effect smothering the surrounding areas. The modular installation combines lighting fittings with the structure's accessories allowing a tailor-made lighting project which can suit any area.

STREAMLIGHT_SYSTEM

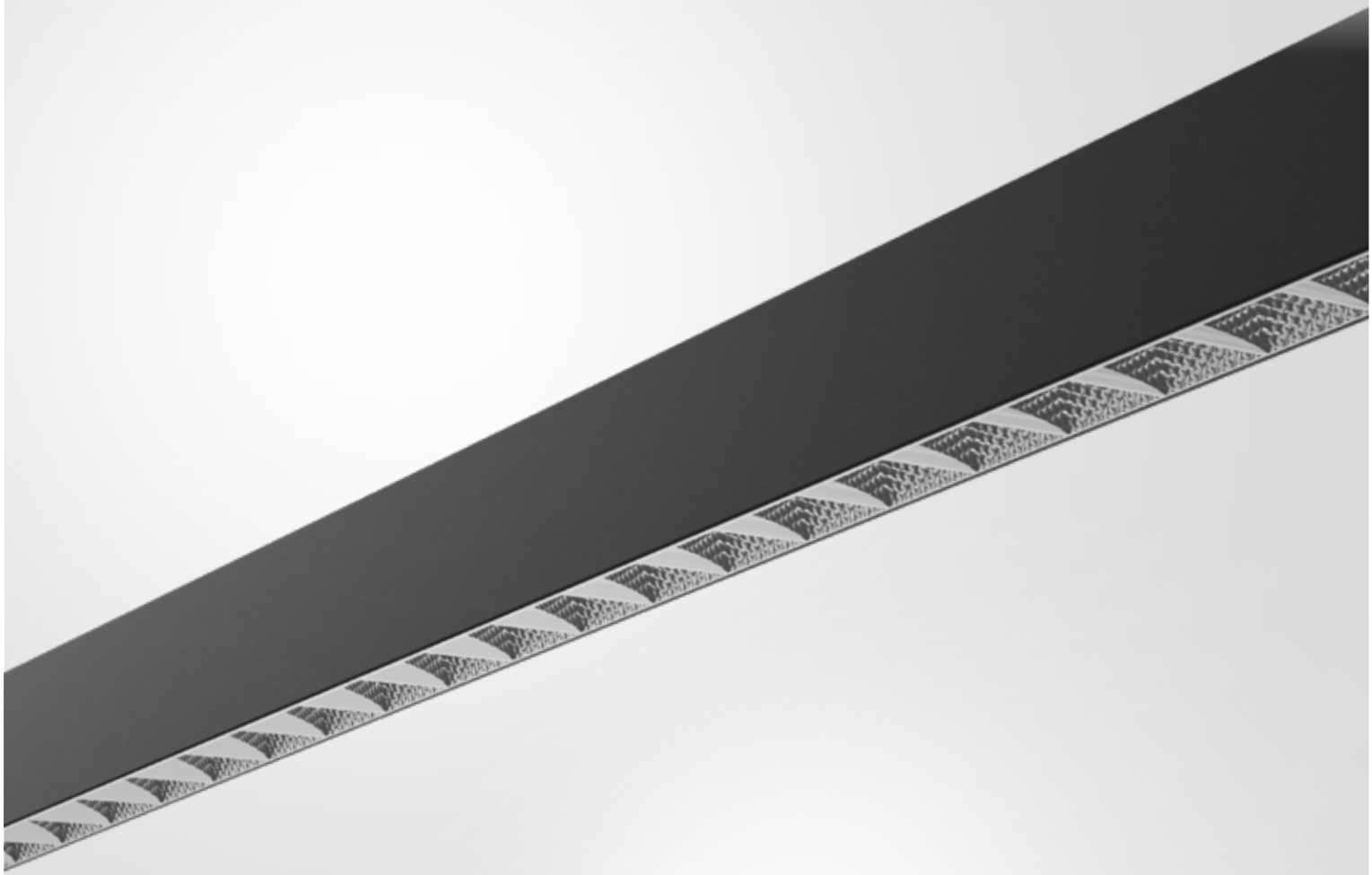

Profilo LED integrato bi-emissione in alluminio estruso.
 Ottiche anti-glare UGR<19 per luce diretta e schermo in PC per luce indiretta.
 Driver integrato. Versioni ON/OFF o Dali.



Extruded aluminium profile equipped with integrated LED for direct and indirect lighting.
 Anti-glare UGR<19 optical reflectors for direct lighting and PC diffuser for indirect lighting.
 Integrated Driver. ON/OFF or DALI version

STREAMLIGHT_SYSTEM



CODE	FINISHING	BEAM	WATT	KELVIN	LED	LUMEN	CRI	PF	DRIVER	KG
42654	Bianco/White	85°*85°	27W+3W	3000K	SAMSUNG	2700+300	>82	0,9	ON-OFF	1,8
42655	Nero/Black	85°*85°	27W+3W	3000K	SAMSUNG	2700+300	>82	0,9	ON-OFF	1,8
42656	Bianco/White	85°*85°	27W+3W	4000K	SAMSUNG	2700+300	>82	0,9	ON-OFF	1,8
42657	Nero/Black	85°*85°	27W+3W	4000K	SAMSUNG	2700+300	>82	0,9	ON-OFF	1,8
42658	Bianco/White	85°*85°	27W+3W	3000K	SAMSUNG	2700+300	>82	0,9	Dali	1,8
42659	Nero/Black	85°*85°	27W+3W	3000K	SAMSUNG	2700+300	>82	0,9	Dali	1,8
42660	Bianco/White	85°*85°	27W+3W	4000K	SAMSUNG	2700+300	>82	0,9	Dali	1,8
42661	Nero/Black	85°*85°	27W+3W	4000K	SAMSUNG	2700+300	>82	0,9	Dali	1,8

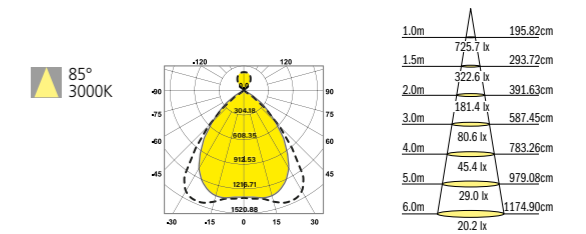
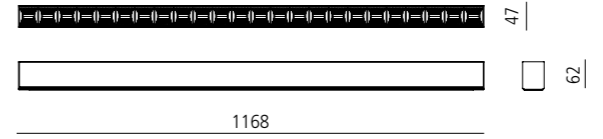

CODE	FINISHING	BEAM	WATT	KELVIN	LED	LUMEN	CRI	PF	DRIVER	KG
42662	Bianco/White	85°*85°	41W+4W	3000K	SAMSUNG	4500+500	>82	0,9	ON-OFF	3,5
42663	Nero/Black	85°*85°	41W+4W	3000K	SAMSUNG	4500+500	>82	0,9	ON-OFF	3,5
42664	Bianco/White	85°*85°	41W+4W	4000K	SAMSUNG	4500+500	>82	0,9	ON-OFF	3,5
42665	Nero/Black	85°*85°	41W+4W	4000K	SAMSUNG	4500+500	>82	0,9	ON-OFF	3,5
42666	Bianco/White	85°*85°	41W+4W	3000K	SAMSUNG	4500+500	>82	0,9	Dali	3,5
42667	Nero/Black	85°*85°	41W+4W	3000K	SAMSUNG	4500+500	>82	0,9	Dali	3,5
42668	Bianco/White	85°*85°	41W+4W	4000K	SAMSUNG	4500+500	>82	0,9	Dali	3,5
42669	Nero/Black	85°*85°	41W+4W	4000K	SAMSUNG	4500+500	>82	0,9	Dali	3,5

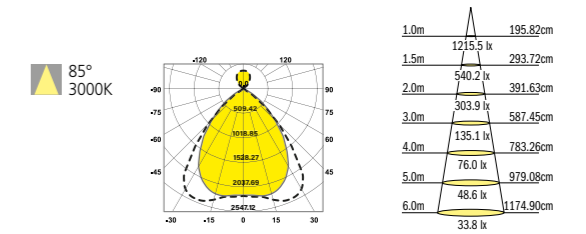
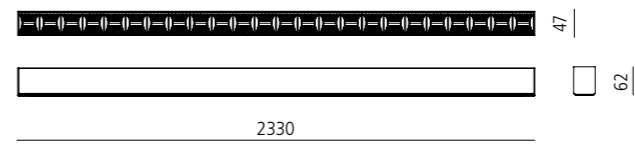

STREAMLIGHT_SYSTEM



CODE	FINISHING	DESCRIPTION
42672	Nero / Black	Congiunzione Lineare/Linear Connector

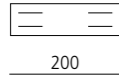

STREAMLIGHT_SYSTEM



CODE	FINISHING	DESCRIPTION
42679	Nero / Black	Testate (2 Pcs.)/End-Caps
42680	Bianco / White	Testate (2 Pcs.)/End-Caps



CODE	FINISHING	DESCRIPTION
42673	Nero / Black	Giunto-L/L-Connector
42674	Bianco / White	Giunto-L/L-Connector

47

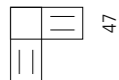

CODE	FINISHING	DESCRIPTION
42681	/	Sospensione acciaio 2 mt (1 pz) / Steel cable 2 mt (1 pc)
42682	Nero/Black	Sospensione e rosone 2 mt (1 pz) / Suspension and canopy 2 mt (1 pc)
42685	Bianco / White	Sospensione e rosone 2 mt (1 pz) / Suspension and canopy 2 mt (1 pc)



CODE	FINISHING	DESCRIPTION
42677	Nero / Black	Giunto T/T-Connector
42678	Bianco / White	Giunto T/T-Connector

47

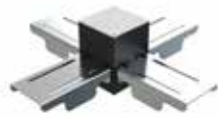

CODE	FINISHING	DESCRIPTION
42675	Nero / Black	Giunto Croce/X-Connector
42676	Bianco / White	Giunto Croce/X-Connector

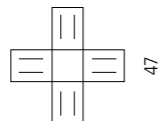

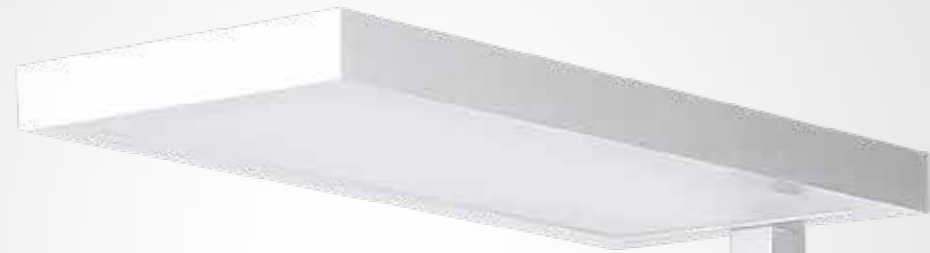

Lampada da terra dimmerabile bi-emissione LED integrato.
Corpo in alluminio estruso anodizzato e schermo anti-glare UGR<19 per luce diretta e schermo trasparente per luce indiretta. Driver OSRAM.

Dimmable LED floor-lamp for direct and indirect lighting. Extruded and anodized aluminium body with anti-glare UGR<19 diffuser for direct lighting and transparent diffuser for indirect lighting. OSRAM driver.



CODE	FINISHING	BEAM	WATT	KELVIN	LED	LUMEN	CRI	PF	DRIVER	KG
41182	Anodized Aluminium	70°	20W+70W	3000K	SAMSUNG	1800 + 7200	>80	>0,98	Dimmerabile	13,6
41148	Anodized Aluminium	70°	20W+70W	4000K	SAMSUNG	1900 + 8000	>80	>0,98	Dimmerabile	13,6

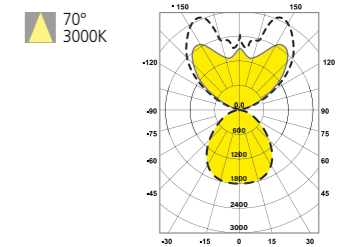
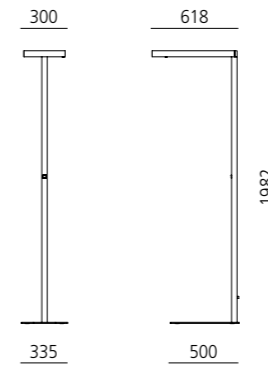

DRESS YOUR TRACK

Una soluzione architettonica pensata per vestire il binario elettrificato nelle sue varie composizioni.

Un profilo in alluminio estruso che oltre ad inglobare il binario offre un vano superiore che può essere utilizzato sia come canalina di servizio sia per alloggiare un'illuminazione indiretta. TRACK_COVER permette di trasformare un binario standard in un prodotto consono ad essere inserito in contesti architettonici.

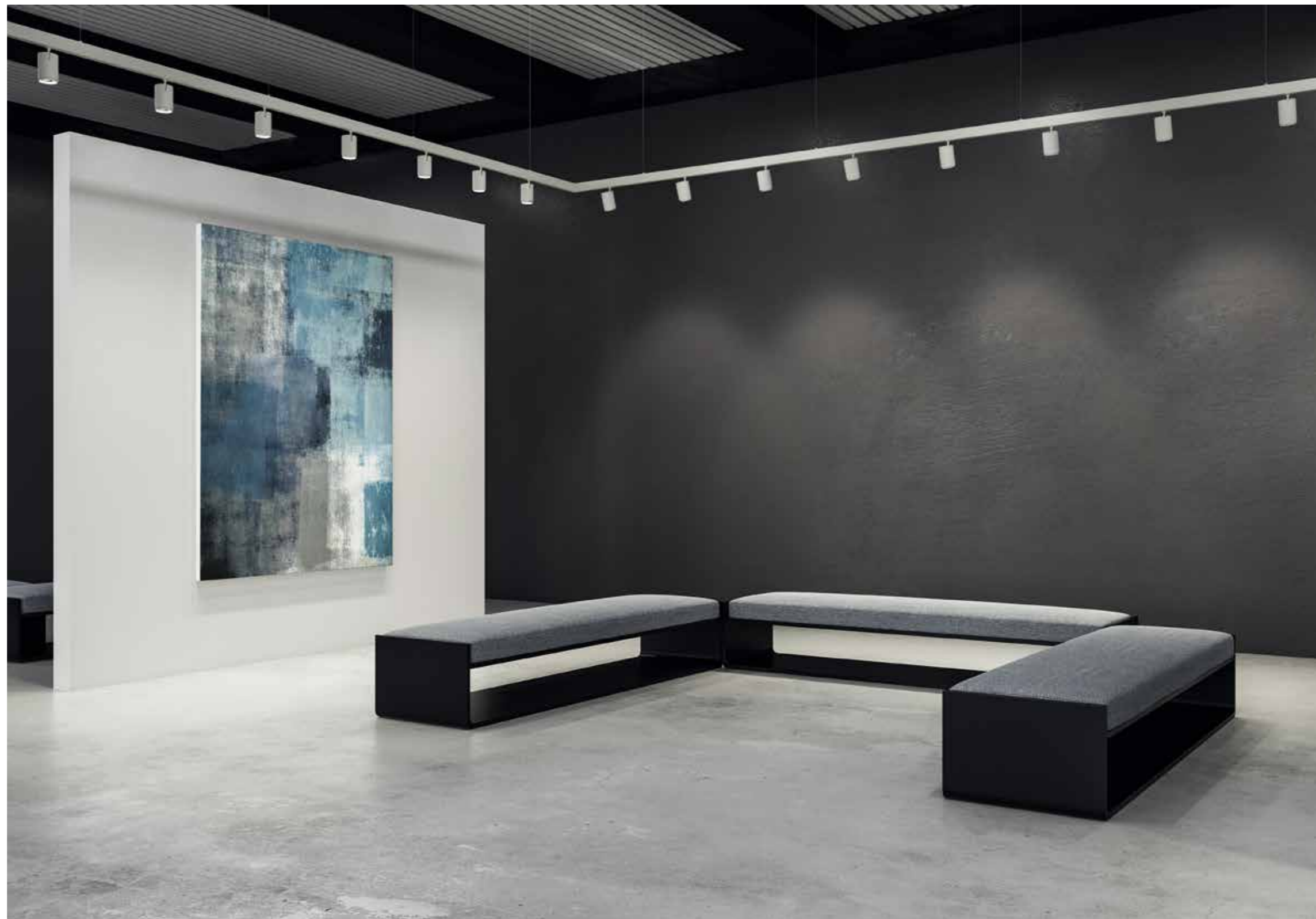

An architectural solution designed to dress a standard track and accompany it through its different compositions.

An extruded aluminium profile which not only does it contain the track, but it also offers an upper area which can be used as wiring space or it can eventually host other lighting fittings for indirect lighting. TRACK_COVER is able to turn a standard track into a product which can perfectly suit an architectural environment.

TRACK_COVER



CODE	FINISHING	DESCRIPTION	KG
60127	Bianco/White	TRACK_COVER profilo 1mt/TRACK_COVER profile 1mt	1,5
60130	Nero/Black	TRACK_COVER profilo 1mt/TRACK_COVER profile 1mt	1,5
60128	Bianco/White	TRACK_COVER profilo 2mt/TRACK_COVER profile 2mt	3,0
60131	Nero/Black	TRACK_COVER profilo 2mt/TRACK_COVER profile 2mt	3,0
60129	Bianco/White	TRACK_COVER profilo 3mt/TRACK_COVER profile 3mt	4,5
60132	Nero/Black	TRACK_COVER profilo 3mt/TRACK_COVER profile 3mt	4,5

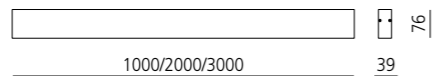

CODE	FINISHING	DESCRIPTION
60133	Nero/Black	Testata 1 pz / End cap 1 pc
60134	Bianco/White	Testata 1 pz / End cap 1 pc

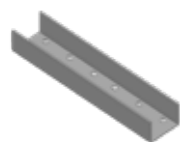

CODE	FINISHING	DESCRIPTION
60135	/	Congiunzione Lineare/Linear Connector

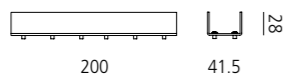

CODE	FINISHING	DESCRIPTION
60137	Bianco/White	Giunto L/L-Connector
60138	Nero/Black	Giunto L/L-Connector

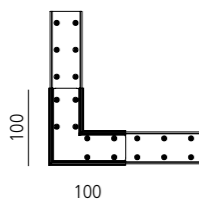

TRACK_COVER

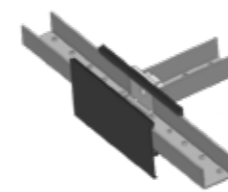

CODE	FINISHING	DESCRIPTION
60139	Bianco/White	Giunto T/T-Connector
60140	Nero/Black	Giunto T/T-Connector

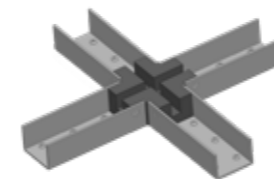
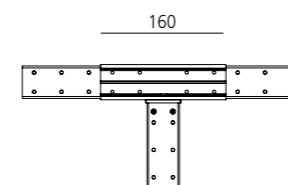

CODE	FINISHING	DESCRIPTION
60141	Bianco/White	Giunto X/X-Connector
60142	Nero/Black	Giunto X/X-Connector

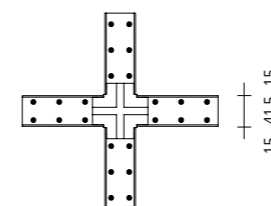

CODE	FINISHING	DESCRIPTION
60143	Bianco/White	Attacco soffitto / Ceiling bracket
60144	Nero/Black	Attacco soffitto / Ceiling bracket



CODE	FINISHING	DESCRIPTION
60145	Bianco/White	Sospensione 1,5 mt / Pendant kit 1,5 mt
60146	Nero/Black	Sospensione 1,5 mt / Pendant kit 1,5 mt



LINE_DEEP INCASSO



Profilo in alluminio estruso anodizzato
 Montaggio a raso senza cassaforme
 Illuminazione generale o d'accento a seconda del
 montaggio
 Schermo rientrante in PC opale
 Ampia gamma di potenze

Extruded anodized aluminium profile
 Trimless mounting without any framework
 General or accent lighting depending on
 installation
 Opal PC recess diffuser
 Wide range of wattages available

LINE_DEEP INCASSO



CODE	FINISHING	DESCRIPTION	KG
11910	Bianco/White	Profilo 2 mt / Profile 2 mt	1,3

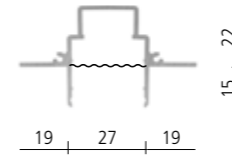
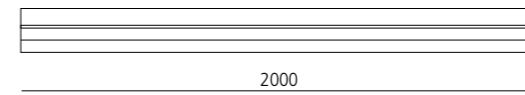

CODE	FINISHING	DESCRIPTION
21305	Opale/Opal	Schermo 2 mt / Diffuser 2mt
21304	Satinato/Frosted	Schermo 2 mt / Diffuser 2mt
21303	Trasparente/Trasparente	Schermo 2 mt / Diffuser 2mt



CODE	FINISHING	BEAM	WATT	KELVIN	LED	LUMEN	CRI	IP
41063	Bianco/White	60°	3,5W	3000K	Epistar	250	>90	44/20
41064	Nero/Black	60°	3,5W	3000K	Epistar	250	>90	44/20



60°
3000K

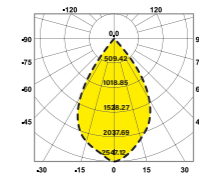

Distance (m)	Beam Diameter (cm)	Beam Diameter (cm)
1.0m	280.35lx	117.90cm
2.0m	70.09lx	235.80cm
3.0m	31.15lx	353.69cm
4.0m	17.52lx	471.59cm
5.0m	11.21lx	589.49cm

DRIVERS

CODE	DRIVER
12557	Plug-in Driver ON-OFF Pri. 220-240V Sec. 6-12V DC 300mA PF >0,5
12556	Plug-in Driver DIMMERABILE TRIAC Pri. 220-240V Sec. 6-12V DC 300mA PF >0,5

Incasso LED integrato fisso e basculante.
Corpo in pressofusione di alluminio.
Riflettore brillantato.
Schermo in PC trasparente.
Plug-in driver escluso.

Fixed and adjustable LED downlight
Die-cast aluminium body
Multi-faceted reflector
Transparent PC diffuser
Plug-in driver not included



CODE	FINISHING	BEAM	WATT	KELVIN	LED	LUMEN	CRI	IP
41065	Bianco/White	60°	3,5W	3000K	Epistar	250	>90	20
41066	Nero/Black	60°	3,5W	3000K	Epistar	250	>90	20

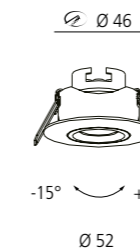

60°
3000K

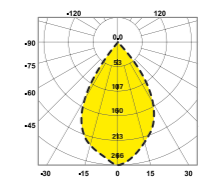

Distance (m)	Beam Diameter (cm)	Beam Diameter (cm)
1.0m	262.37lx	119.86cm
2.0m	65.59lx	239.72cm
3.0m	29.15lx	359.58cm
4.0m	16.40lx	479.43cm
5.0m	10.49lx	599.29cm

DRIVERS

CODE	DRIVER
12557	Plug-in Driver ON-OFF Pri. 220-240V Sec. 6-12V DC 300mA PF >0,5
12556	Plug-in Driver DIMMERABILE TRIAC Pri. 220-240V Sec. 6-12V DC 300mA PF >0,5

HYPER_DICRO + BLITZ



Moduli dicroici ad alte prestazioni con indice resa cromatica >90
Cornici in alluminio pressofuso verniciato IP65 per installazione in controsoffitto.
Driver ON/OFF, 1-10V o Dali.



MR-16 high performance modules with CRI >90
IP65 die-cast aluminium frames for recessed ceiling installation
ON/OFF, 1-10V or Dali driver

HYPER_DICRO



Ø 50



Ø 46

CODE	FINISHING	BEAM	WATT	KELVIN	LED	LUMEN	CRI	KG
42638	Alu	38°	8,5W	2700K	CREE	533	>90	0,08
42639	Alu	38°	8,5W	3000K	CREE	574	>90	0,08
42640	Alu	38°	8,5W	4000K	CREE	615	>90	0,08

CODE	DRIVER
42641	Plug-in Driver AC100-240V 30-42V 280mA Flicker Free
42642	Plug-in DALI driver AC100-240V 30-42V 280mA Flicker Free
42643	Plug-in Driver 1-10V AC100-240V 30-42V 280mA Flicker Free

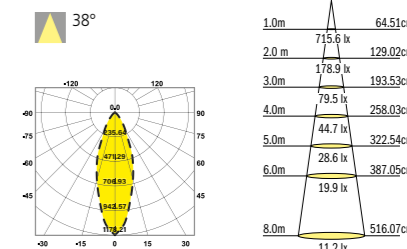

Ø 50

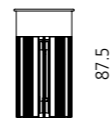

Ø 46

CODE	FINISHING	BEAM	WATT	KELVIN	LED	LUMEN	CRI	KG
42644	Alu	38°	13W	2700K	CREE	738	>90	0,1
42645	Alu	38°	13W	3000K	CREE	820	>90	0,1
42646	Alu	38°	13W	4000K	CREE	902	>90	0,1

CODE	DRIVER
42647	Plug-in Driver AC100-240V 30-42V 280mA Flicker Free
42648	Plug-in DALI driver AC100-240V 30-42V 280mA Flicker Free
42649	Plug-in Driver 1-10V AC100-240V 30-42V 280mA Flicker Free

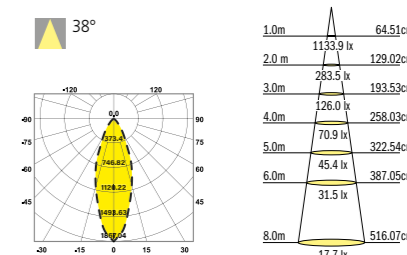

BLITZ



CODE	FINISHING	DESCRIPTION
42650	Bianco/White	cornice tonda da incasso per Hyper Dicro / Recessed round frame for Hyper Dicro
42651	Nero/Black	cornice tonda da incasso per Hyper Dicro / Recessed round frame for Hyper Dicro

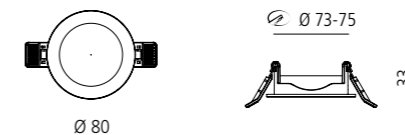

CODE	FINISHING	DESCRIPTION
42652	Bianco/White	cornice quadrata da incasso per Hyper Dicro / Recessed square frame for Hyper Dicro
42653	Nero/Black	cornice quadrata da incasso per Hyper Dicro / Recessed square frame for Hyper Dicro

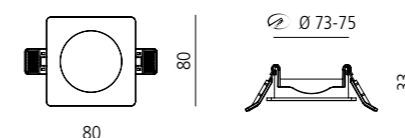

**LET'S
GO
OUTSIDE**

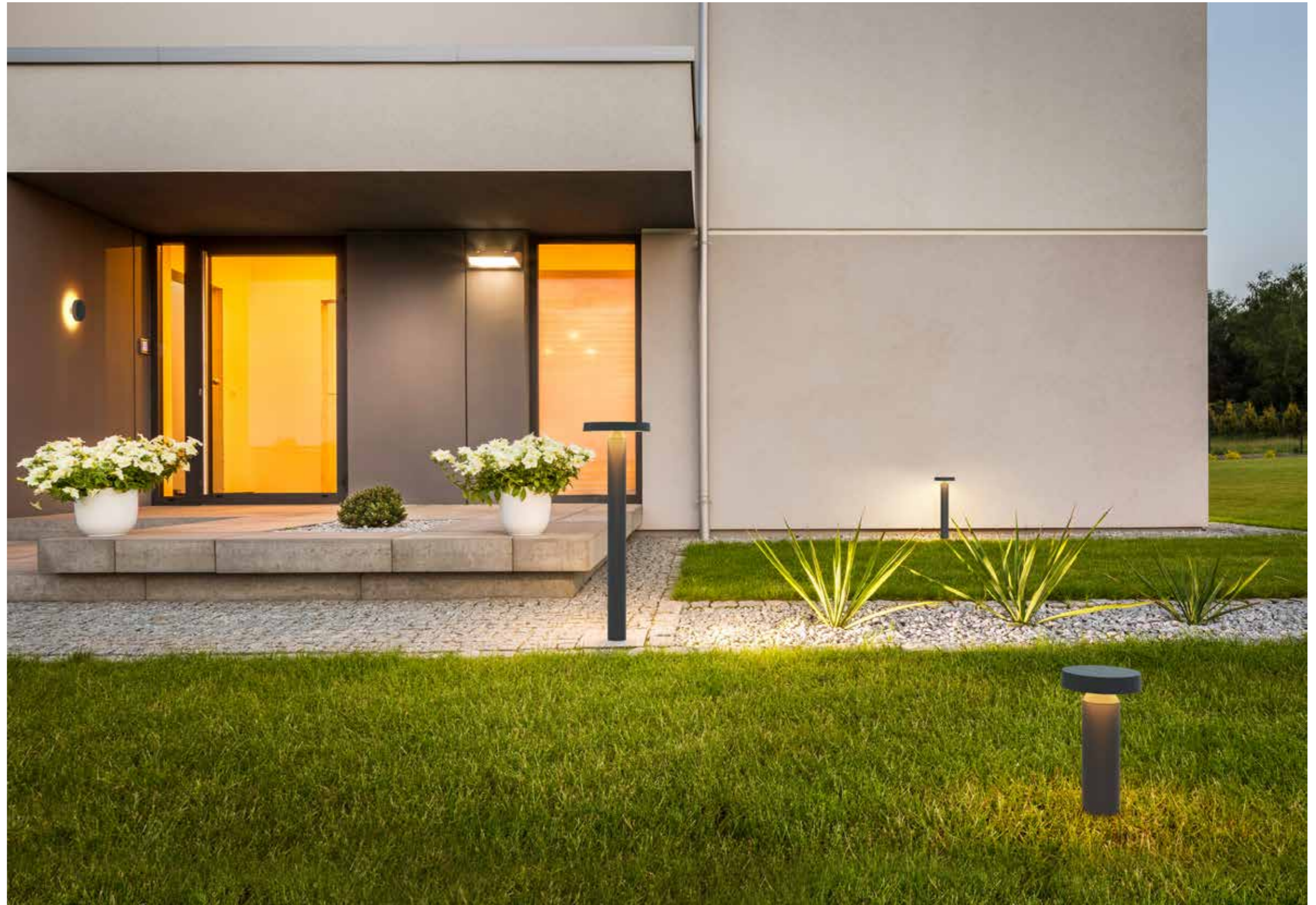



Apparecchi LED integrati per esterno.
Corpo in alluminio estruso verniciato.
Schermo in PC opale
Versioni a paletto e parete.

Outdoor fittings with built-in LED
Body in painted extruded aluminium
Opal PC diffuser
Bollard and wall versions



CODE	FINISHING	BEAM	WATT	KELVIN	LED	LUMEN	CRI	PF	DRIVER	KG
41167	Antracite/Anthracite	90°	10W	3000K	RF2835	700	80	0,5	250VDC/32mA	1,3

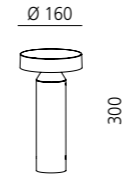

CODE	FINISHING	BEAM	WATT	KELVIN	LED	LUMEN	CRI	PF	DRIVER	KG
41168	Antracite/Anthracite	90°	15W	3000K	RF2835	1050	80	0,5	250VDC/48mA	1,6

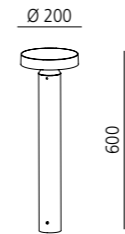

CODE	FINISHING	BEAM	WATT	KELVIN	LED	LUMEN	CRI	PF	DRIVER	KG
41169	Antracite/Anthracite	100°	20W	3000K	RF2835	1400	80	0,5	250VDC/64mA	2

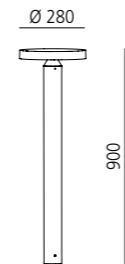

CODE	FINISHING	BEAM	WATT	KELVIN	LED	LUMEN	CRI	PF	DRIVER	KG
41166	Antracite/Anthracite	90°	15W	3000K	RF2835	1050	80	0,5	250VDC/48mA	0,9

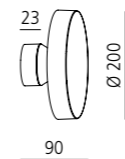

CODE	DESCRIPTION
11554	Distanziale per parete / Wall mounting spacer



Apparecchi LED integrati per esterno.
 Corpo in alluminio estruso verniciato.
 Ottica basculante.
 Schermo in PC trasparente.
 Versioni a paletto e parete.

Outdoor fittings with built-in LED
 Body in painted extruded aluminium
 Adjustable source
 Transparent PC diffuser
 Bollard and wall versions



CODE	FINISHING	BEAM	WATT	KELVIN	LED	LUMEN	CRI	PF	DRIVER	KG
41165	Antracite/Anthracite	120°	8W	3000K	RF2835	560	80	0,5	250VDC/48mA	1,7

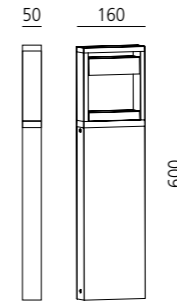

CODE	FINISHING	BEAM	WATT	KELVIN	LED	LUMEN	CRI	PF	DRIVER	KG
41164	Antracite/Anthracite	120°	8W	3000K	RF2835	560	80	0,5	250VDC/25mA	1,1

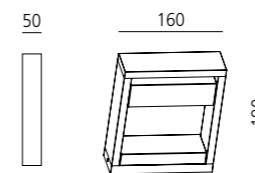

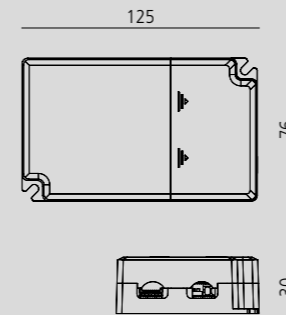
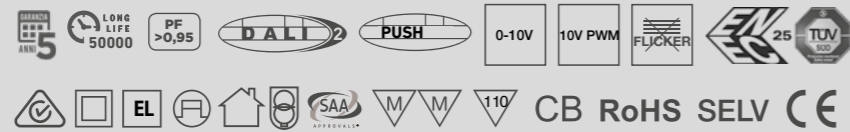

CODE	INPUT	OUTPUT VOLTAGE	OUTPUT CURRENT	DIP #1	DIP #2	DIP #3	DIP #4	DIP #5	Typ. PF	Typ. EFF.	Typ. THD
42683	200-240V	14-42V	1100mA	ON	ON	ON	ON	-	0,95	87,5%	< 10%
			1050mA	-	ON	ON	ON	-	0,95	87,5%	< 10%
			1000mA	ON	-	ON	ON	-	0,95	87,5%	< 10%
			950mA	-	-	ON	ON	-	0,95	87,5%	< 10%
			900mA	-	ON	ON	-	-	0,95	87,5%	< 10%
			850mA	ON	-	ON	-	-	0,95	87,0%	< 10%
			800mA	-	-	ON	-	-	0,90	87,0%	< 10%
			750mA	-	ON	-	-	-	0,90	87,0%	< 10%
			700mA	ON	-	-	-	-	0,90	86,5%	< 10%
42684	200-240V	14-42V	650mA	-	-	-	-	-	0,90	86,5%	< 10%
			600mA	ON	-	ON	ON	-	0,95	87,5%	< 10%
			550mA	-	-	ON	ON	-	0,95	87,5%	< 10%
			500mA	-	ON	ON	-	-	0,95	87,5%	< 10%
			450mA	ON	-	ON	-	-	0,95	87,0%	< 10%
			400mA	-	-	ON	-	-	0,90	87,0%	< 10%
			350mA	-	ON	-	-	-	0,90	87,0%	< 10%
			300mA	ON	-	-	-	-	0,90	86,5%	< 10%
			250mA	-	-	-	-	-	0,90	86,5%	< 10%

One4all: including DALI-2, PUSH-DIM, 0-10V, 10V PWM dimming; also, corridor FUNCTION available. 4 DIP switches for output current or corridorFUNCTION adjust. Flicker free when taking phone, or in CCTV monitor.

FEATURES & BENEFITS

- DALI member, compatible with universal DALI masters
- Tested in DALI house according to IEC 62386 parts 101,102(DALI-2), 207
- Adjustable constant current output
- Reliable, Class II, SELV according EN 61347
- Independent and with strain-relief
- Permissible AC cable 0.5-1.5mm² wire gauge, 3.5-8mm PVC jacket diameter
- All terminals are screw-less, easy and quick for installation
- One cable relief struction design,only need one time screw lock
- Working Ta=-25°C ~ +45°C
- 50,000 hrs nominal lifespan
- 5-year factory guarantee
- Flicker Free
- Built-in active PFC

FUNCTIONS

- Over current protection
- Over voltage protection
- Over temperature protection
- Over load protection
- Short-circuit protection
- No-load protection

Wiring diagram for PUSH DIM

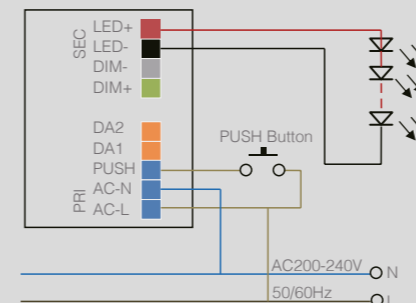

Wiring diagram for DALI

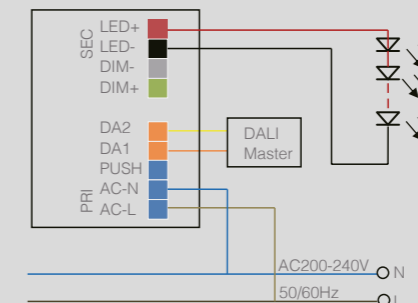

Wiring diagram for 0-10V, or 10V PWM

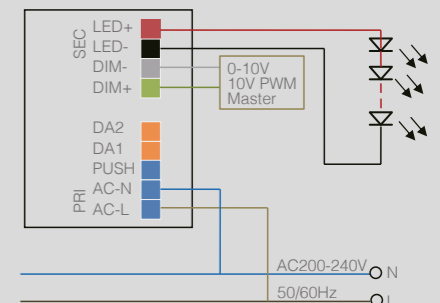

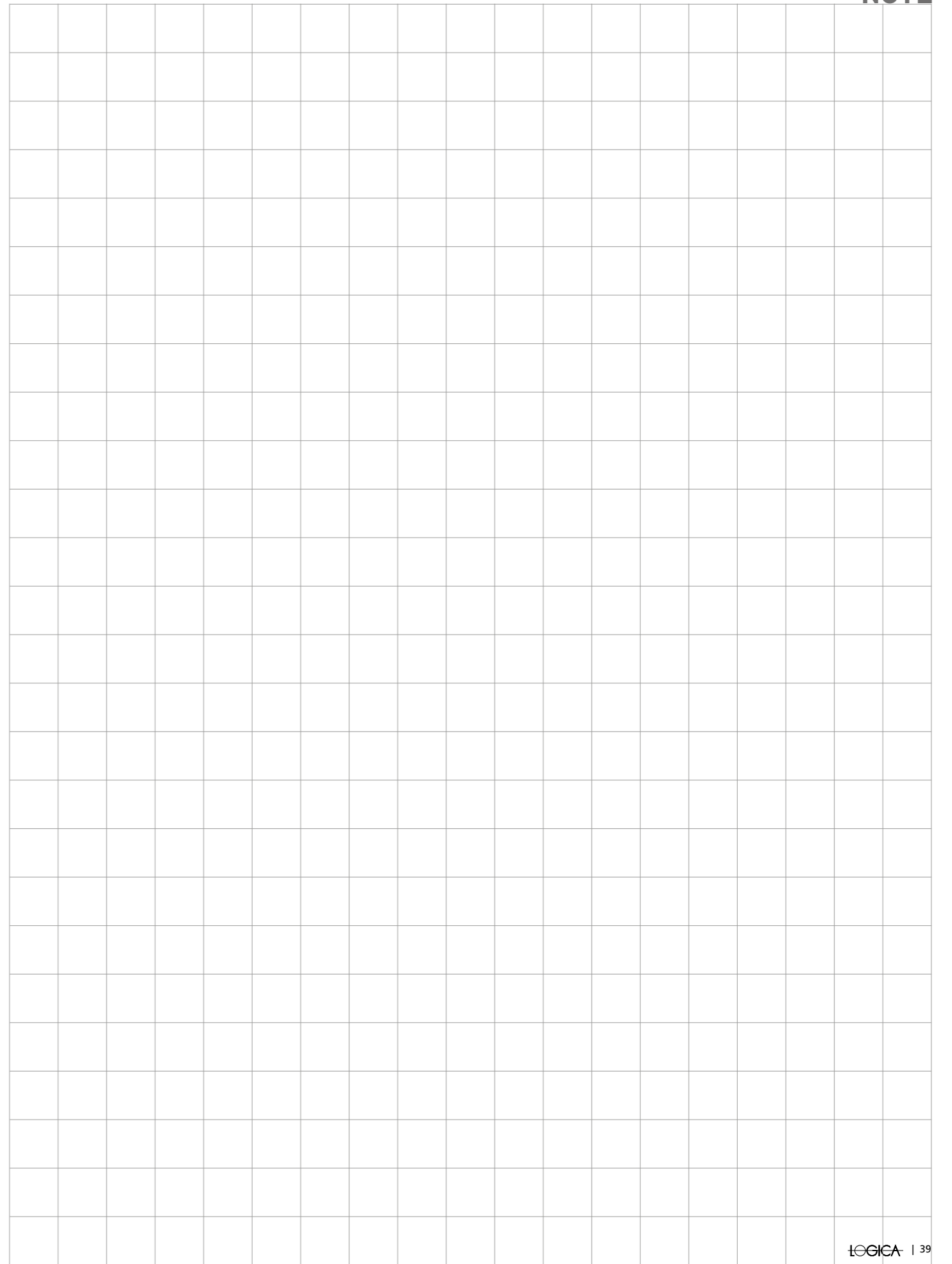
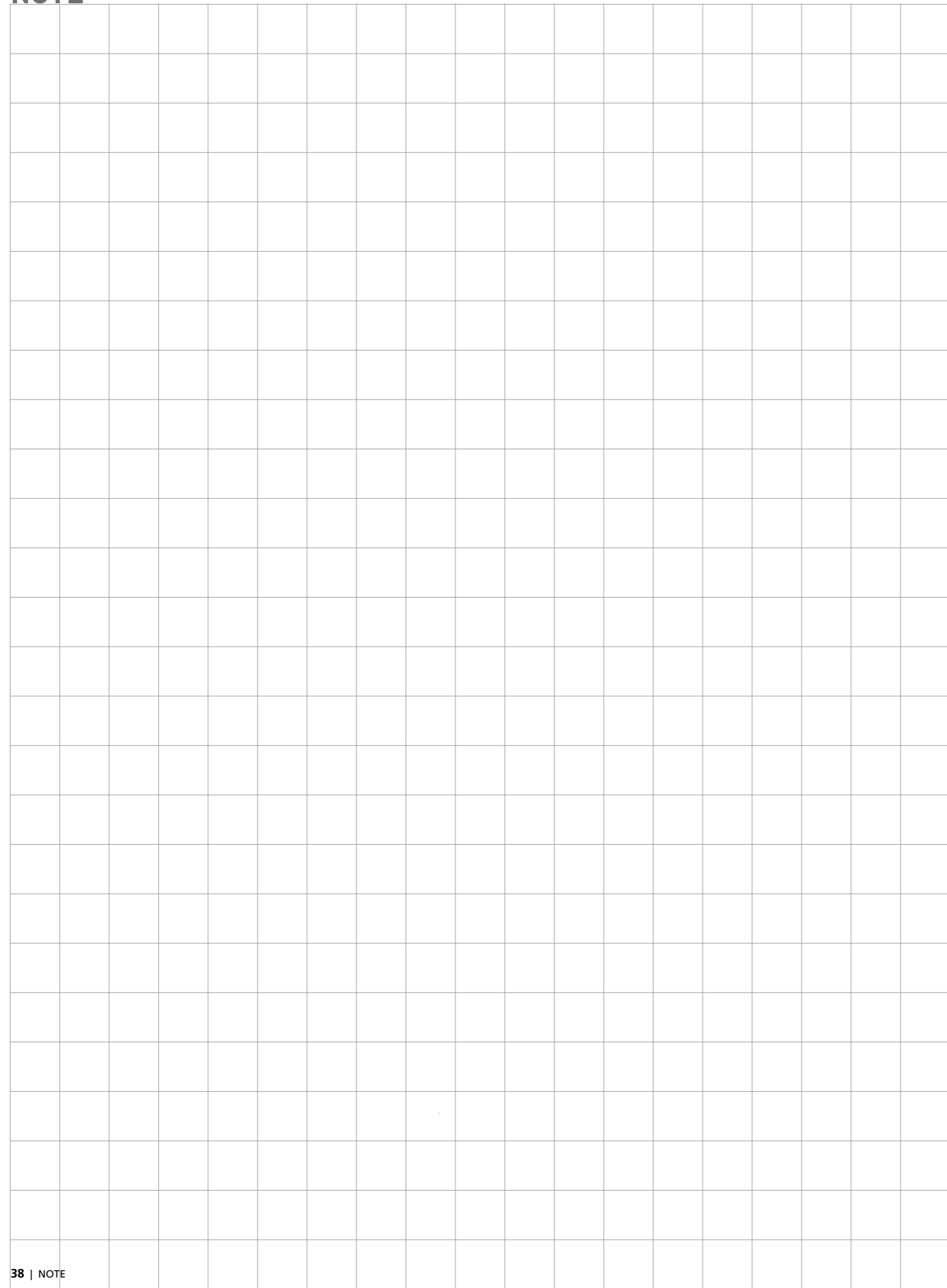



MARINOCRISTAL

Marino Cristal S.p.A.

Via Guardia del Consiglio 29

47899 Serravalle - Rep. di San Marino

Tel. (+378) 0549-901188

Fax (+378) 0549-900612

www.marinocristal.com

email: marinocristal@marinocristal.com

È vietata la riproduzione anche parziale di questo catalogo
It is forbidden to reproduce any part of this catalogue