



CATALOGO CONTRACT

/ 2019



CATALOGO CONTRACT

**PROTEZIONE,
SICUREZZA,
EFFICIENZA.**

Homega Contracting nasce dalla pluriennale esperienza della Marino Cristal nel campo dell'illuminazione.

Questa divisione studiata per l'illuminazione di grandi aree industriali offre apparecchi e sorgenti luminose di ottima qualità e con una elevata efficienza energetica. Una gamma prodotto creata per soddisfare le svariate esigenze di illuminazione usufruendo della migliore tecnologia LED che il mercato offre.

I prodotti Homega Contracting si contraddistinguono per gli alti rendimenti ed il mantenimento del flusso luminoso a fine vita. Inoltre un'accurata progettazione illuminotecnica permette di dimensionare il progetto in maniera da ottenere risultati ottimali sia in termini di illuminazione che di efficientamento energetico.

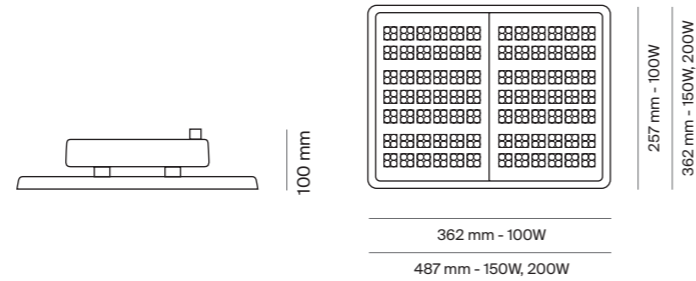

HORUS

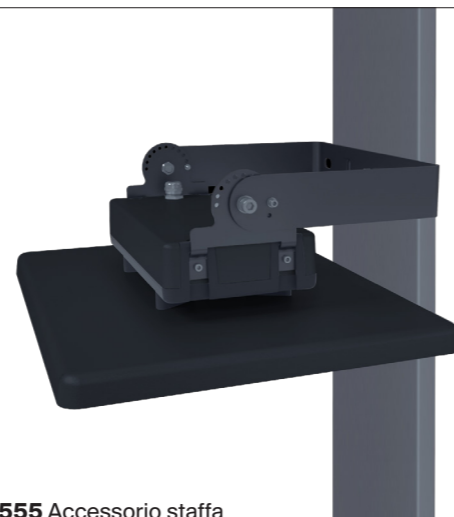
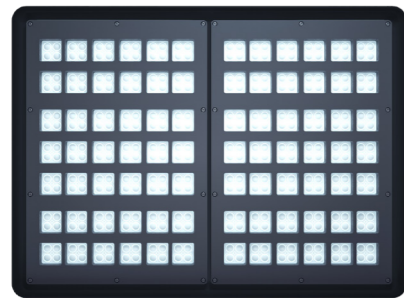









11555 Accessorio staffa

Horus

Apparecchio LED integrato per installazione a sospensione ed a parete con staffa (accessorio). Corpo in alluminio per un'ottima conduttività termica e ottiche per gestire al meglio la distribuzione della luce. Led CREE / Driver Meanwell



	       		
Specifiche	41597	41598	41599
watt	100W	150W	200W
lumen	13000	19500	26000
angolo	80°	80°	80°
colore luce	4000K	4000K	4000K
CRI	>80	>80	>80
finitura	nero	nero	nero
alimentazione	220-240V 50/60Hz	220-240V 50/60Hz	220-240V 50/60Hz
PF	>0,9	>0,9	>0,9
T° d'esercizio	-40°÷70°C	-40°÷70°C	-40°÷70°C
kg	4,9	6,5	6,5
vita utile media	50000h	50000h	50000h

Curve fotometriche

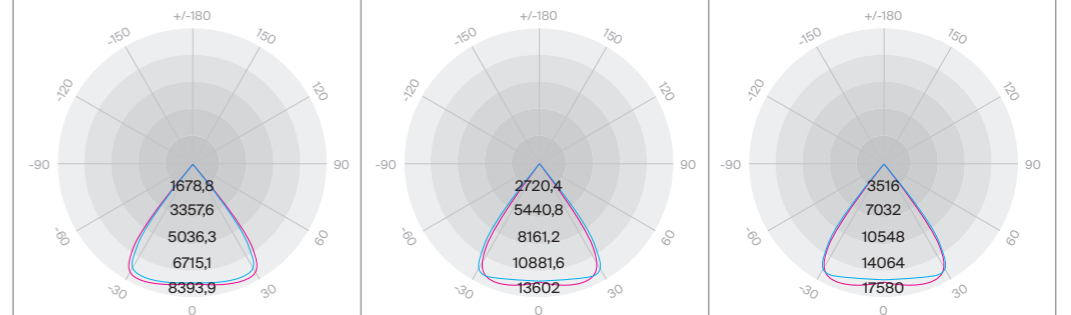

Distance (m)	Beam Diameter (cm)	Light Intensity (lx)
1m	163 cm	7854,8 lx
2m	327 cm	1963,7 lx
3m	490 cm	872,76 lx
4m	654 cm	490,93 lx
5m	818 cm	314,19 lx
6m	981 cm	218,19 lx
7m	1145 cm	160,30 lx
8m	1308 cm	122,73 lx
9m	1472 cm	96,973 lx
10m	1636 cm	78,548 lx



Aton

Apparecchio LED integrato per installazione a sospensione o su blindosbarra.
Corpo in alluminio estruso per un'ottima conduttività termica ed ottiche per gestire al meglio la distribuzione della luce.
Led PHILIPS / Driver Meanwell

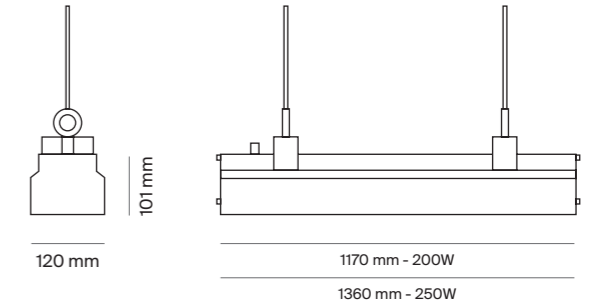

Specifiche	IK08 IP65	
	41642	41643
watt	200W	250W
lumen	24000	30000
angolo	60° x 110°	60° x 110°
colore luce	4000K	4000K
CRI	>80	>80
finitura	nero	nero
alimentazione	220-240V 50/60Hz	220-240V 50/60Hz
PF	>0,9	>0,9
T° d'esercizio	-40°÷70°C	-40°÷70°C
kg	9,2	10,3
vita utile media	50000h	50000h

Curve fotometriche

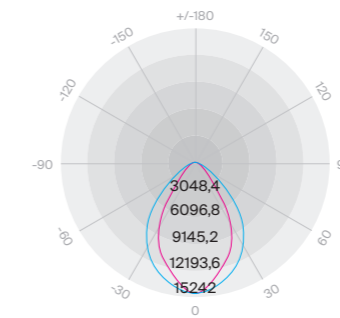

1m	15195 lx	125 cm
2m	3798,7 lx	250 cm
3m	1688,3 lx	375 cm
4m	949,68 lx	501 cm
5m	607,79 lx	626 cm
6m	422,08 lx	751 cm
7m	310,10 lx	876 cm
8m	237,42 lx	1002 cm
9m	187,59 lx	1127 cm
10m	151,95 lx	1252 cm

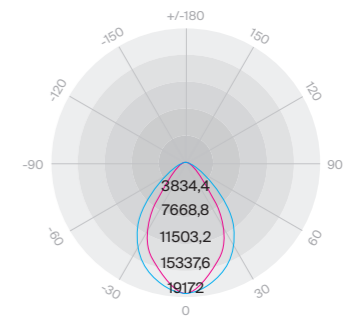

1m	19113 lx	125 cm
2m	4778,2 lx	250 cm
3m	2123,6 lx	375 cm
4m	1194,5 lx	501 cm
5m	764,51 lx	626 cm
6m	530,91 lx	751 cm
7m	390,05 lx	876 cm
8m	298,63 lx	1002 cm
9m	235,96 lx	1127 cm
10m	191,13 lx	1252 cm



PRO STAGNA LED

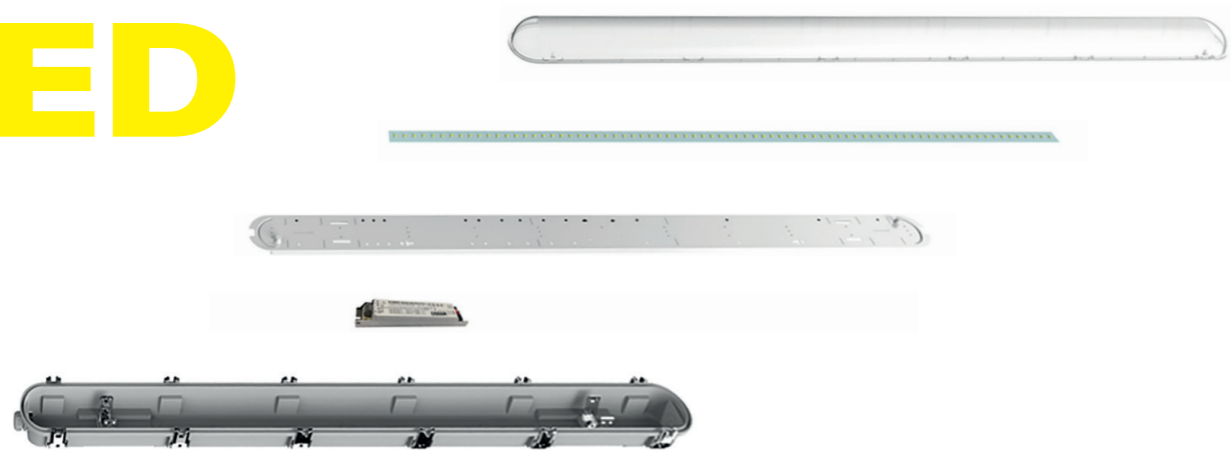

Pro_Stagna LED

Apparecchio LED integrato per installazione a soffitto o su blindosbarra.
Corpo in PC grigio e schermo in PC satinato.
Led LG / Driver OSRAM

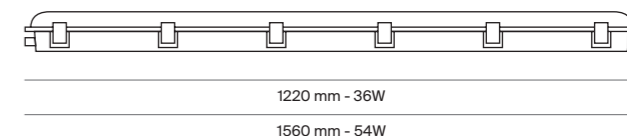

Specifiche	41640	41641	41644	41645
watt	36W	54W	36W	54W
lumen	3900	5900	3900	5900
angolo	120°	120°	120°	120°
colore luce	4000K	4000K	4000K	4000K
CRI	>80	>80	>80	>80
finitura	grigia	grigia	grigia	grigia
alimentazione	175-250V 50/60Hz	175-250V 50/60Hz	175-250V 50/60Hz	175-250V 50/60Hz
PF	>0,9	>0,9	>0,9	>0,9
T° d'esercizio	-25°÷45°C	-25°÷45°C	-25°÷45°C	-25°÷45°C
kg	1,7	2,1	1,7	2,1
vita utile media	35000h	35000h	35000h	35000h

Versioni con emergenza 4W 3/h

Curve fotometriche

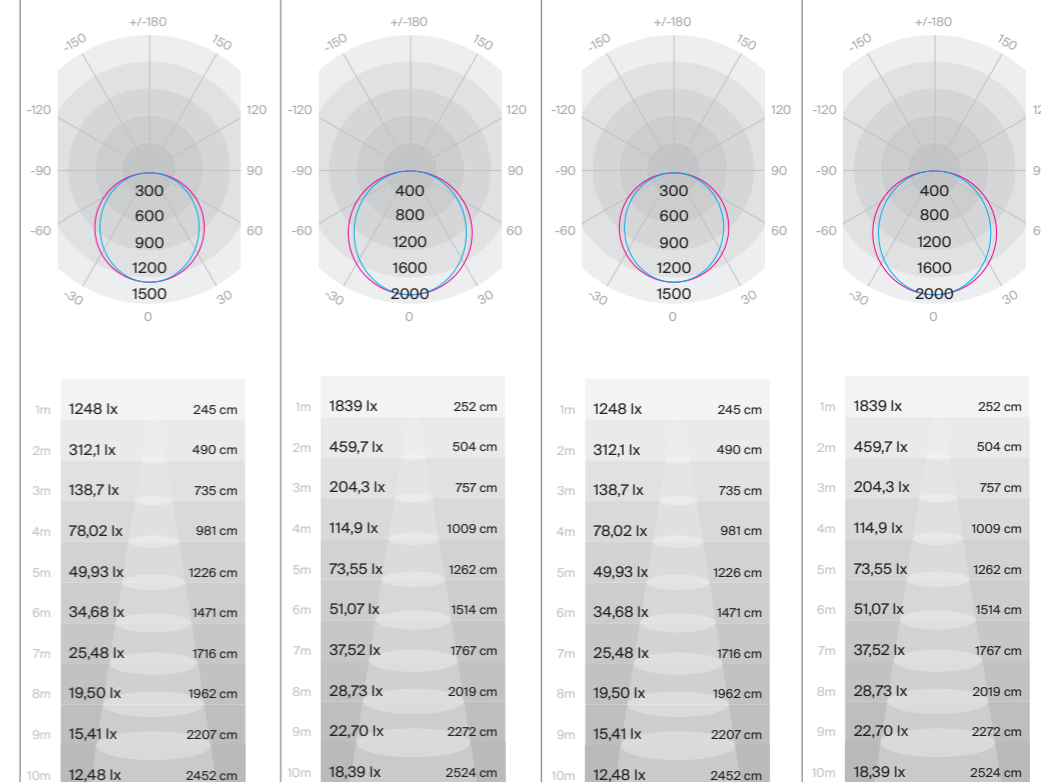



ATLANTE



Atlante

Proiettore da esterno LED integrato
Corpo in alluminio pressofuso
ed ottiche in PC trasparente.
Led BRIDGELUX / Driver HOMEGA

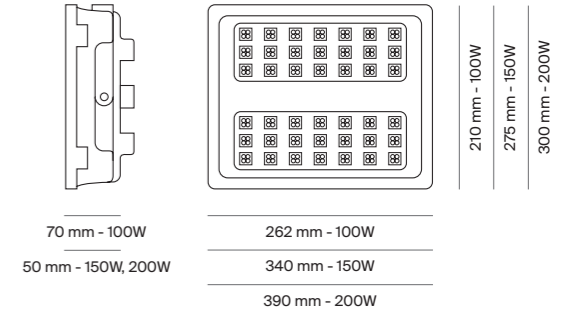

Specifiche	41170	41171	41172																																													
watt	100W	150W	200W																																													
lumen	9500	14250	19000																																													
angolo	85° x 95°	85° x 95°	85° x 95°																																													
colore luce	4000K	4000K	4000K																																													
CRI	>80	>80	>80																																													
finitura	nero	nero	nero																																													
alimentazione	220-240V 50/60Hz	220-240V 50/60Hz	220-240V 50/60Hz																																													
PF	>0,9	>0,9	>0,9																																													
T° d'esercizio	-25°÷45°C	-25°÷45°C	-25°÷45°C																																													
kg	2,4	4,5	5,7																																													
vita utile media	20000h	20000h	20000h																																													
Curve fotometriche																																																
	<table border="1"> <tr><td>1m</td><td>5611 lx</td><td>177 cm</td></tr> <tr><td>2m</td><td>1403 lx</td><td>354 cm</td></tr> <tr><td>3m</td><td>623,4 lx</td><td>532 cm</td></tr> <tr><td>4m</td><td>350,7 lx</td><td>709 cm</td></tr> <tr><td>5m</td><td>224,4 lx</td><td>886 cm</td></tr> </table>	1m	5611 lx	177 cm	2m	1403 lx	354 cm	3m	623,4 lx	532 cm	4m	350,7 lx	709 cm	5m	224,4 lx	886 cm	<table border="1"> <tr><td>1m</td><td>7676 lx</td><td>181 cm</td></tr> <tr><td>2m</td><td>1919 lx</td><td>363 cm</td></tr> <tr><td>3m</td><td>852,9 lx</td><td>544 cm</td></tr> <tr><td>4m</td><td>479,8 lx</td><td>726 cm</td></tr> <tr><td>5m</td><td>307,1 lx</td><td>908 cm</td></tr> </table>	1m	7676 lx	181 cm	2m	1919 lx	363 cm	3m	852,9 lx	544 cm	4m	479,8 lx	726 cm	5m	307,1 lx	908 cm	<table border="1"> <tr><td>1m</td><td>10294 lx</td><td>173 cm</td></tr> <tr><td>2m</td><td>2574 lx</td><td>347 cm</td></tr> <tr><td>3m</td><td>1144 lx</td><td>520 cm</td></tr> <tr><td>4m</td><td>643,4 lx</td><td>694 cm</td></tr> <tr><td>5m</td><td>411,8 lx</td><td>867 cm</td></tr> </table>	1m	10294 lx	173 cm	2m	2574 lx	347 cm	3m	1144 lx	520 cm	4m	643,4 lx	694 cm	5m	411,8 lx	867 cm
1m	5611 lx	177 cm																																														
2m	1403 lx	354 cm																																														
3m	623,4 lx	532 cm																																														
4m	350,7 lx	709 cm																																														
5m	224,4 lx	886 cm																																														
1m	7676 lx	181 cm																																														
2m	1919 lx	363 cm																																														
3m	852,9 lx	544 cm																																														
4m	479,8 lx	726 cm																																														
5m	307,1 lx	908 cm																																														
1m	10294 lx	173 cm																																														
2m	2574 lx	347 cm																																														
3m	1144 lx	520 cm																																														
4m	643,4 lx	694 cm																																														
5m	411,8 lx	867 cm																																														

T8 universal

Tubo LED ad alta efficienza
 Ampissima compatibilità
 con alimentatori elettronici
 e con tutti gli elettromeccanici.

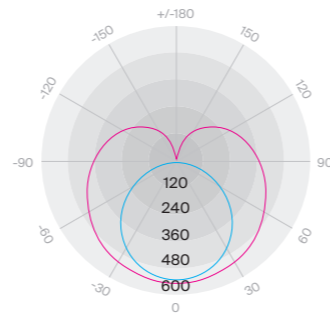

Curva fotometrica

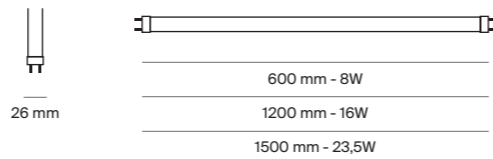

Tubo LED ad alta efficienza
 Ampissima compatibilità
 con alimentatori elettronici

T5 universal

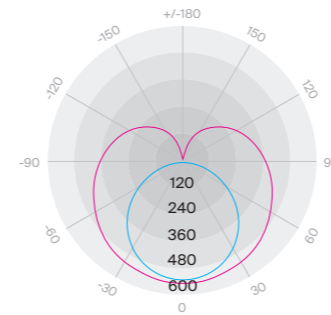
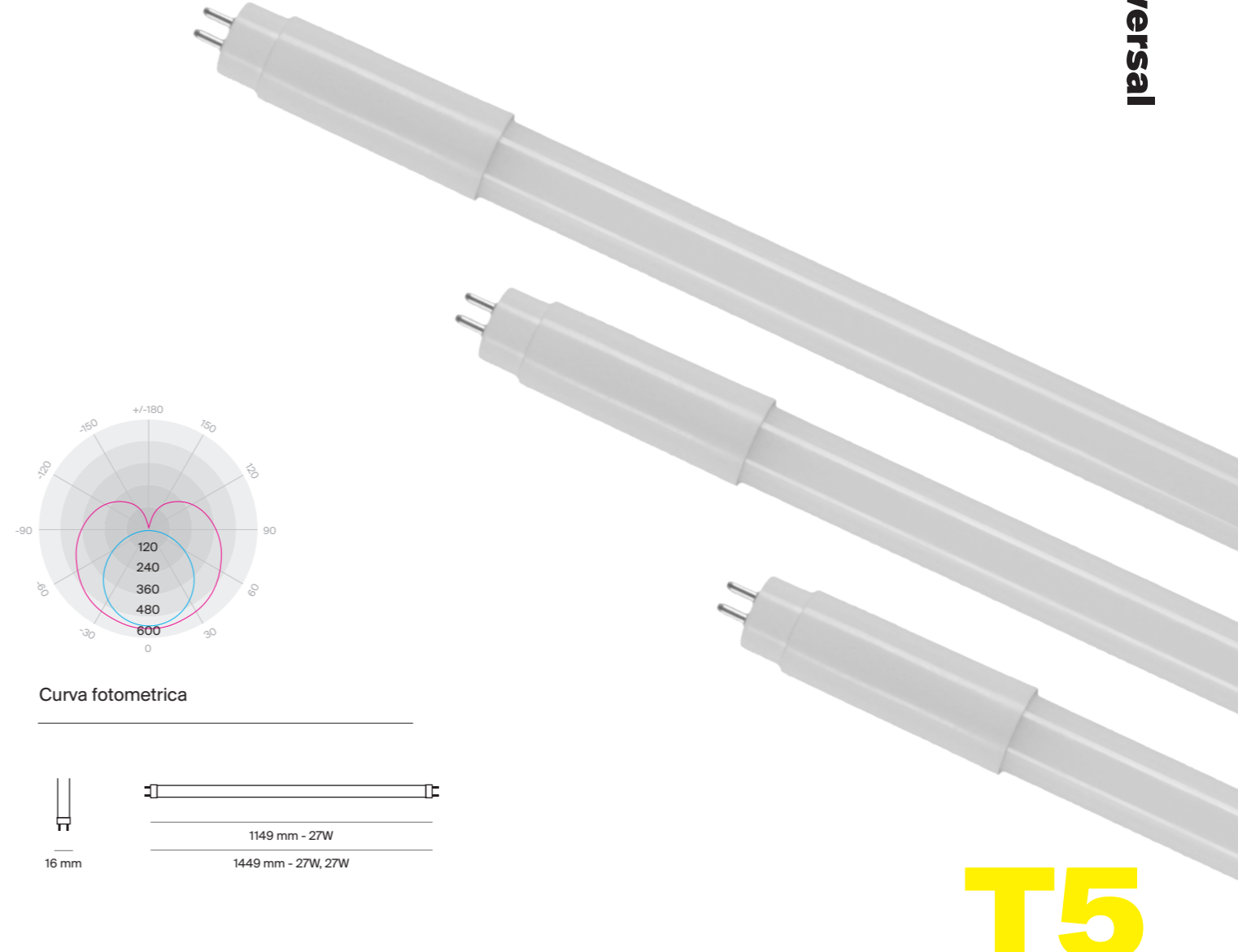

Curva fotometrica

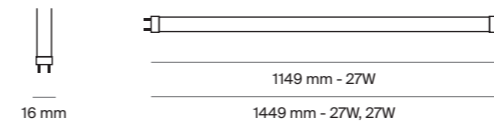

T8

Specifiche			
	21537	21538	21533
watt	8W	16W	23,5W
watt / fluo	18W	36W	58W
attacco	G13	G13	G13
lumen	1050	2250	3400
angolo	270°	270°	270°
colore luce	4000K	4000K	4000K
CRI	>80	>80	>80
PF	>0,9	>0,9	>0,9
T° d'esercizio	-25°÷45°C	-25°÷45°C	-25°÷45°C
vita utile media	40000h	40000h	40000h

T5

Specifiche						
	21541	21542	21543	21544	21571	21572
watt	27W	27W	27W	27W	37W	37W
watt / fluo	54W 1200mm	54W 1200mm	49W 1500mm	49W 1500mm	80W 1500mm	80W 1500mm
attacco	G5	G5	G5	G5	G5	G5
lumen	3780	3780	3780	3780	5180	5180
angolo	175°	175°	175°	175°	175°	175°
colore luce	3000K	4000K	3000K	4000K	3000K	4000K
CRI	>80	>80	>80	>80	>80	>80
PF	>0,9	>0,9	>0,9	>0,9	>0,9	>0,9
T° d'esercizio	-25°÷45°C	-25°÷45°C	-25°÷45°C	-25°÷45°C	-25°÷45°C	-25°÷45°C
vita utile media	40000h	40000h	40000h	40000h	40000h	40000h

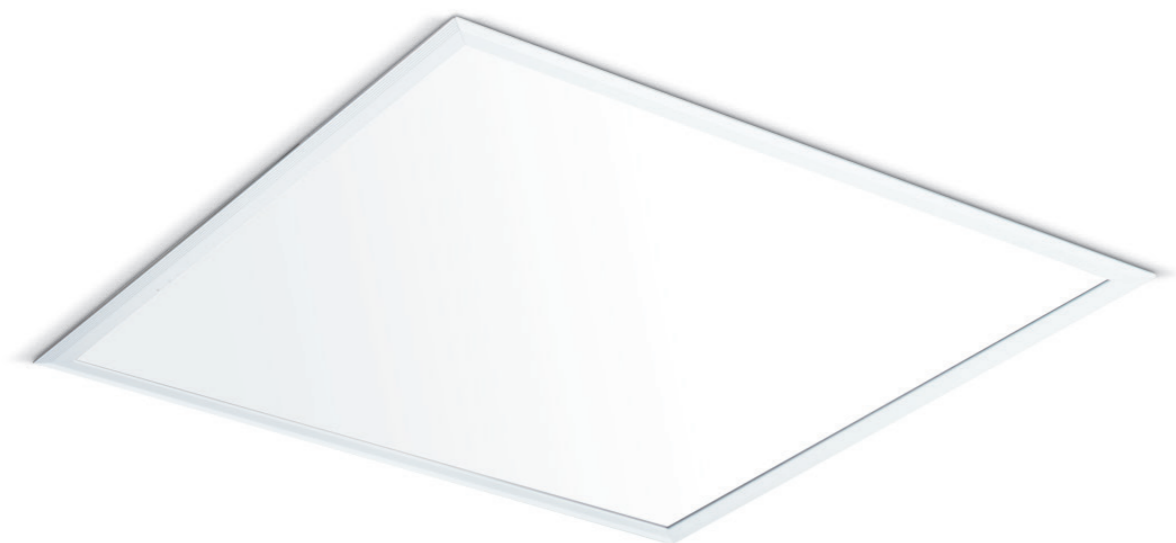

PRO PANNELLO LED

42538 Cornice per montaggio cartongesso (620x620 mm)



42539 Accessorio soffitto H mm.43



11622/2 Accessorio sospensione H mt.2



- 12549** Kit emergenza 1/h
- 12550** Kit emergenza 3/h
- 12835** Driver dimmerabile (0-10, 1-10V, Dali e Push)

Pro_Pannello LED

Apparecchio LED integrato per installazione in controsoffitto a pannelli 60x60cm. Con gli accessori opzionali può essere montato nei controsoffitti in cartongesso, a plafone e a sospensione. Corpo in alluminio, diffusore in PMMA e schermo opale.

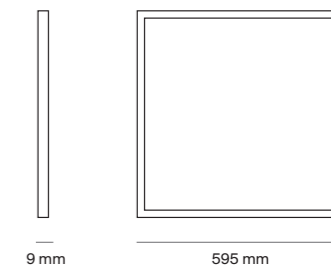

Specifiche	40222	40224	40223	40225
watt	36W	45W	36W	45W
lumen	3200	4000	3400	4200
angolo	120°	120°	120°	120°
colore luce	3000K	3000K	4000K	4000K
CRI	>80	>80	>80	>80
finitura	bianco	bianco	bianco	bianco
alimentazione	220-240V 50/60Hz	220-240V 50/60Hz	220-240V 50/60Hz	220-240V 50/60Hz
PF	>0,9	>0,9	>0,9	>0,9
T° d'esercizio	-25°÷45°C	-25°÷45°C	-25°÷45°C	-25°÷45°C
kg	3,11	3,11	3,11	3,11
vita utile media	45000h	45000h	45000h	45000h

Curve fotometriche

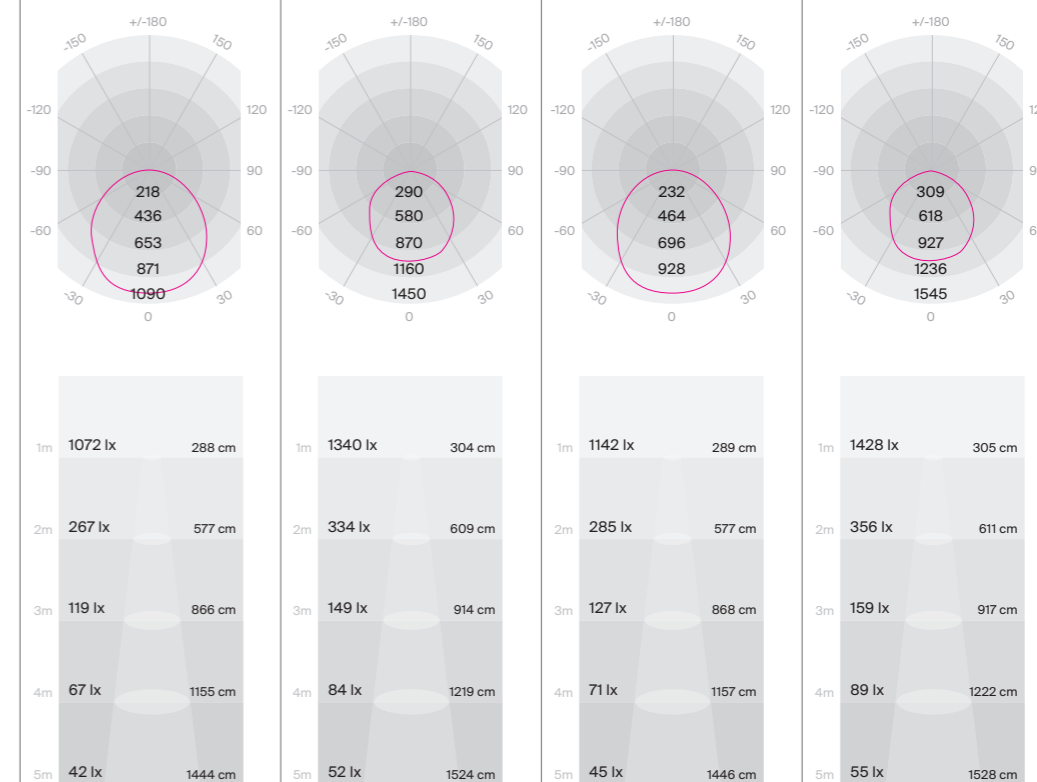



Ω **HOMEGA**
CONTRACTING

è un marchio di:

Marino Cristal S.p.A.
Via Guardia del Consiglio, 29
47899 Serravalle, Rep. di San Marino
tel. +378 0549 901188
fax +378 0549 900612
marinocristal@marinocristal.com
www.marinocristal.com