



BOOK 2018
LED LIGHTING
SOLUTION

 **HOMEGA[®]**
ILLUMINAZIONE

BOOK 2018
LED LIGHTING
SOLUTION

Ω HOME GA[®]
ILLUMINAZIONE

| | | | |
|-----------------------------------------|-----------|-----------------------------------|-----------|
| INTERNO | 4 | ESTERNO | 46 |
| INCASSI | 4 | INDUSTRIALE/ARCHITETTURALE | 46 |
| DIN | 12 | CARONTE | 48 |
| DON | 13 | STAGNA_IP65 | 50 |
| HELIOS_50 | 16 | T8_LED | 51 |
| HELIOS_50 | 17 | | |
| LEDSPOT_TRP1 | 6 | LUCI PER ESTERNO | 52 |
| QUADRO 30 | 10 | BRICK | 74 |
| SPLASH | 14 | BRICK | 75 |
| VULCANO EVO | 8 | DORA | 65 |
| | | ELEGANT | 73 |
| LUCI PER UFFICIO | 18 | FOLGORE | 58 |
| PANNELLI LED | 20 | HELLO | 72 |
| PANNELLI LED 60X60 | 22 | KANDO_T | 76 |
| PANNELLO LED 60X60 UGR<19 | 24 | KANDO_Q | 77 |
| PANNELLO LED 30X120 | 25 | LADY_T | 66 |
| | | LADY_Q | 67 |
| APLIQUES / PLAFONIERE DA INTERNI | 26 | LAMPO | 56 |
| DISCO | 34 | LUNA_T | 62 |
| HYDRA T | 32 | LUNA_O | 63 |
| HYDRA Q | 33 | MOON | 64 |
| ISIDE | 30 | NAUTICA | 80 |
| LUCE QUADRO | 38 | NAUTICA | 81 |
| LUCE QUADRO | 39 | POSEIDON | 54 |
| MAYA | 36 | PROTEO | 69 |
| MINILED | 41 | RINGO | 78 |
| PANNELLO TONDO | 28 | SIGNUS | 68 |
| PANNELLO QUADRO | 29 | WALLY | 70 |
| REGLED_IP65 | 40 | WALLY OPEN | 71 |
| REGLED | 42 | ZAGOR | 60 |
| SLIMLED | 44 | | |
| WILLYLED | 45 | DRIVERS | 82 |
| | | FOTOMETRIE | 83 |
| | | PRICE LIST | 94 |

RICETTE

CONSIGLIO

INTEGRATORI

RIPERIMENTALI

Lucida
INGASSO





Incasso LED integrato
Corpo in TRP
Diffusore in PC opale
Driver integrato

Recessed fitting with built-in LED
TRP body
Opal PC diffuser
Built-in driver



pag. 84



| CODICE / CODE | 40511 | 40512 | 40513 | 40514 | 40515 | 40516 | 40517 | 40518 |
|-------------------------|-----------------|-----------------|-----------------|-----------------|-----------------|-----------------|-----------------|-----------------|
| COLORE / COLOUR | bianco white | bianco white | bianco white | bianco white | bianco white | bianco white | bianco white | bianco white |
| COLORE LUCE / COLOR T | 3000K | 4000K | 3000K | 4000K | 3000K | 4000K | 3000K | 4000K |
| LUMEN | 825 | 888 | 1242 | 1320 | 2135 | 2332 | 2431 | 2487 |
| CRI | >80 | >80 | >80 | >80 | >80 | >80 | >80 | >80 |
| LED | Epistar | Epistar | Epistar | Epistar | Epistar | Epistar | Epistar | Epistar |
| WATT | 10W | 10W | 15W | 15W | 25W | 25W | 30W | 30W |
| PF | >0,5 | >0,5 | >0,5 | >0,5 | >0,5 | >0,5 | >0,9 | >0,9 |
| SUPPLY | 230V 50/60Hz | 230V 50/60Hz | 230V 50/60Hz | 230V 50/60Hz | 230V 50/60Hz | 230V 50/60Hz | 230V 50/60Hz | 230V 50/60Hz |
| FORO / HOLE | Ø90 | Ø90 | Ø120 | Ø120 | Ø170 | Ø170 | Ø200 | Ø200 |
| KG | 0,14 | 0,14 | 0,20 | 0,20 | 0,33 | 0,33 | 0,45 | 0,45 |
| PCS | 20 | 20 | 20 | 20 | 20 | 20 | 20 | 20 |
| DIMENSIONI / DIMENSIONS | | | | | | | | |
| a | 120 | 120 | 150 | 150 | 200 | 200 | 230 | 230 |
| b | 60 | 60 | 60 | 60 | 60 | 60 | 60 | 60 |



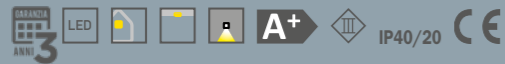

Incasso LED integrato
Corpo in TRP
Diffusore in PC opale
Riflettore cromato
Driver incluso

Recessed fitting with built-in LED
TRP body
Opal PC diffuser
Chromed reflector
Driver included



pag 88



| CODICE / CODE | 40571 | 40572 | 40573 | 40574 | 40575 | 40576 | 40577 | 40578 |
|-------------------------|---------------------|---------------------|---------------------|---------------------|---------------------|---------------------|---------------------|---------------------|
| BEAM | 80° | 75° | 65° | 65° | 80° | 75° | 65° | 65° |
| COLORE / COLOUR | bianco white | bianco white | bianco white | bianco white | bianco white | bianco white | bianco white | bianco white |
| COLORE LUCE / COLOR T | 3000K | 3000K | 3000K | 3000K | 4000K | 4000K | 4000K | 4000K |
| LUMEN | 1000 | 1400 | 1600 | 1900 | 1100 | 1500 | 1700 | 2000 |
| CRI | >80 | >80 | >80 | >80 | >80 | >80 | >80 | >80 |
| LED | Everlight | Everlight | Everlight | Everlight | Everlight | Everlight | Everlight | Everlight |
| WATT | 15W | 20W | 25W | 30W | 15W | 20W | 25W | 30W |
| PF | >0,5 | >0,5 | >0,9 | >0,9 | >0,5 | >0,5 | >0,9 | >0,9 |
| SUPPLY | 220-240V 50/60Hz | 220-240V 50/60Hz | 220-240V 50/60Hz | 220-240V 50/60Hz | 220-240V 50/60Hz | 220-240V 50/60Hz | 220-240V 50/60Hz | 220-240V 50/60Hz |
| KG | 0,25 | 0,35 | 0,47 | 0,47 | 0,25 | 0,35 | 0,47 | 0,47 |
| DRIVER | 140mA/90V | 160mA/108V | 160mA/135V | 240mA/108V | 140mA/90V | 160mA/108V | 160mA/135V | 240mA/108V |
| FORO / HOLE | Ø125 | Ø160 | Ø200 | Ø200 | Ø125 | Ø160 | Ø200 | Ø200 |
| PCS | 40 | 20 | 20 | 20 | 40 | 20 | 20 | 20 |
| DIMENSIONI / DIMENSIONS | | | | | | | | |
| a | 150 | 190 | 230 | 230 | 150 | 190 | 230 | 230 |
| b | 81 | 91 | 101,5 | 101,5 | 81 | 91 | 101,5 | 101,5 |





Incasso LED integrato
Corpo in TRP
Diffusore PC opale
Driver integrato

Recessed fitting with built-in LED
TRP body
Opal PC diffuser
Built-in driver



pag. 87

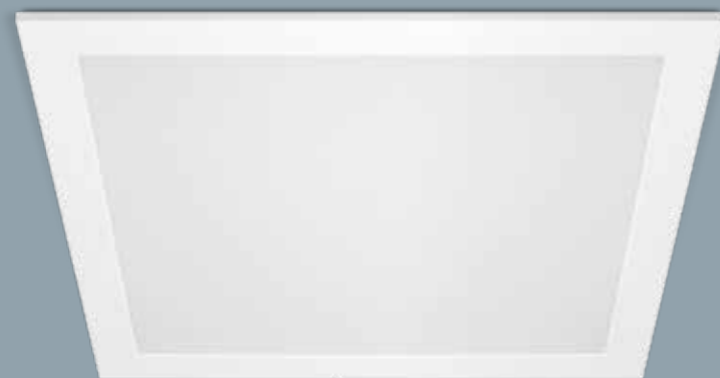

| | | |
|--------------------------------|------------------|------------------|
| CODICE / CODE | 40752 | 40753 |
| BEAM | 111° | 111° |
| COLORE / COLOUR | bianco white | bianco white |
| COLORE LUCE / COLOR T | 3000K | 4000K |
| LUMEN | 2400 | 2500 |
| CRI | >80 | >80 |
| LED | Everlight | Everlight |
| WATT | 30W | 30W |
| PF | >0,9 | >0,9 |
| SUPPLY | 220-240V 50/60Hz | 220-240V 50/60Hz |
| KG | 0,78 | 0,78 |
| FORO / HOLE | 288x288 | 288x288 |
| PCS | 20 | 20 |
| DIMENSIONI / DIMENSIONS | | |
| a | 300x300 | 300x300 |
| b | 65 | 65 |





Incasso LED integrato
Corpo in pressofusione di alluminio verniciato
Schermo in PC trasparente
Driver incluso

Recessed fitting with built-in LED
Painted die-cast aluminium body
Transparent PC screen
Driver included



pag. 90



pag. 90



Incasso LED integrato
Corpo in pressofusione di alluminio
verniciato
Schermo in PC trasparente
Driver incluso

Recessed fitting with built-in LED
Painted die-cast aluminium body
Transparent PC screen
Driver included

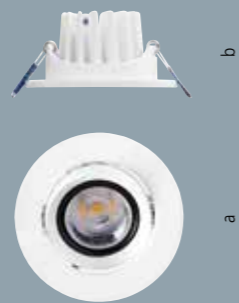

| | |
|--------------------------------|--------------|
| CODICE / CODE | 40210 |
| BEAM | 38° |
| COLORE / COLOUR | bianco/white |
| COLORE LUCE / COLOR T | 3000K |
| LUMEN | 550 |
| CRI | >80 |
| LED | Refong COB |
| WATT | 9W |
| PF | >0,5 |
| SUPPLY | 230V 50/60Hz |
| DRIVER | 108mA/15-30V |
| FORO / HOLE | Ø75 |
| KG | 0,14 |
| PCS | 10 |
| DIMENSIONI / DIMENSIONS | |
| a | 85 |
| b | 42 |

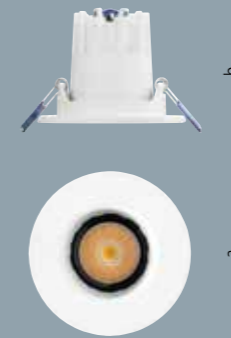

| | |
|--------------------------------|--------------|
| CODICE / CODE | 40211 |
| BEAM | 25° |
| COLORE / COLOUR | bianco/white |
| COLORE LUCE / COLOR T | 3000K |
| LUMEN | 550 |
| CRI | >80 |
| LED | Refong COB |
| WATT | 9W |
| PF | >0,5 |
| SUPPLY | 230V 50/60Hz |
| DRIVER | 108mA/15-30V |
| FORO / HOLE | Ø75 |
| KG | 0,14 |
| PCS | 10 |
| DIMENSIONI / DIMENSIONS | |
| a | 85 |
| b | 65 |



LED HALO    IP65/20 CE

Incasso GU5,3
Corpo in pressofusione di alluminio verniciato
Schermo in vetro trasparente

Recessed fitting GU5,3
Painted die-cast aluminium body
Transparent glass screen

SPLASH



| | | |
|--------------------------------|----------------|----------------|
| CODICE / CODE | 40326 | 40327 |
| COLORE / COLOUR | bianco / white | cromo / chrome |
| LAMP | GU5,3 | GU5,3 |
| WATT | Max 35W | Max 35W |
| SUPPLY | 12V | 12V |
| FORO / HOLE | Ø72 | Ø72 |
| KG | 0,14 | 0,14 |
| PCS | 50 | 50 |
| DIMENSIONI / DIMENSIONS | | |
| a | 82 | 82 |
| b | 36 | 36 |



Incasso
Corpo in pressofusione di alluminio verniciato

Recessed fitting
Painted die-cast aluminium body



| CODICE / CODE | 40388 | 40389 | 40390 | 40391 | 40392 |
|--------------------------------|-----------------|---------------|-------------|-----------------|---------------|
| COLORE / COLOUR | bianco white | nero black | oro gold | cromo chrome | nikel matt |
| LAMP | GU5,3 | GU5,3 | GU5,3 | GU5,3 | GU5,3 |
| WATT | Max 50W | Max 50W | Max 50W | Max 50W | Max 50W |
| SUPPLY | 12V | 12V | 12V | 12V | 12V |
| FORO / HOLE | Ø63 | Ø63 | Ø63 | Ø63 | Ø63 |
| KG | 0,1 | 0,1 | 0,1 | 0,1 | 0,1 |
| PCS | 100 | 100 | 100 | 100 | 100 |
| DIMENSIONI / DIMENSIONS | | | | | |
| a | 76 | 76 | 76 | 76 | 76 |
| b | 55 | 55 | 55 | 55 | 55 |

ACCESSORI
ACCESSORIES



40482 Kit GU10 / GZ10

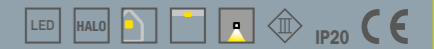

Incasso
Corpo in pressofusione di alluminio

Recessed fitting
Painted die-cast aluminium body

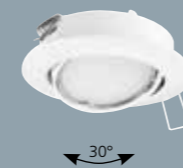

| CODICE / CODE | 40396 | 40397 | 40398 | 40399 | 40395 |
|--------------------------------|-----------------|---------------|-------------|-----------------|---------------|
| COLORE / COLOUR | bianco white | nero black | oro gold | cromo chrome | nikel matt |
| LAMP | GU5,3 | GU5,3 | GU5,3 | GU5,3 | GU5,3 |
| WATT | Max 50W | Max 50W | Max 50W | Max 50W | Max 50W |
| SUPPLY | 12V | 12V | 12V | 12V | 12V |
| FORO / HOLE | Ø74 | Ø74 | Ø74 | Ø74 | Ø74 |
| KG | 0,1 | 0,1 | 0,1 | 0,1 | 0,1 |
| PCS | 100 | 100 | 100 | 100 | 100 |
| DIMENSIONI / DIMENSIONS | | | | | |
| a | 80 | 80 | 80 | 80 | 80 |
| b | 45 | 45 | 45 | 45 | 45 |

ACCESSORI
ACCESSORIES



40482 Kit GU10 / GZ10



luci per
UFFICIO

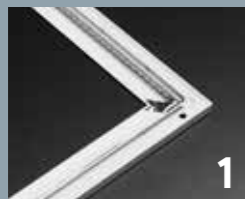
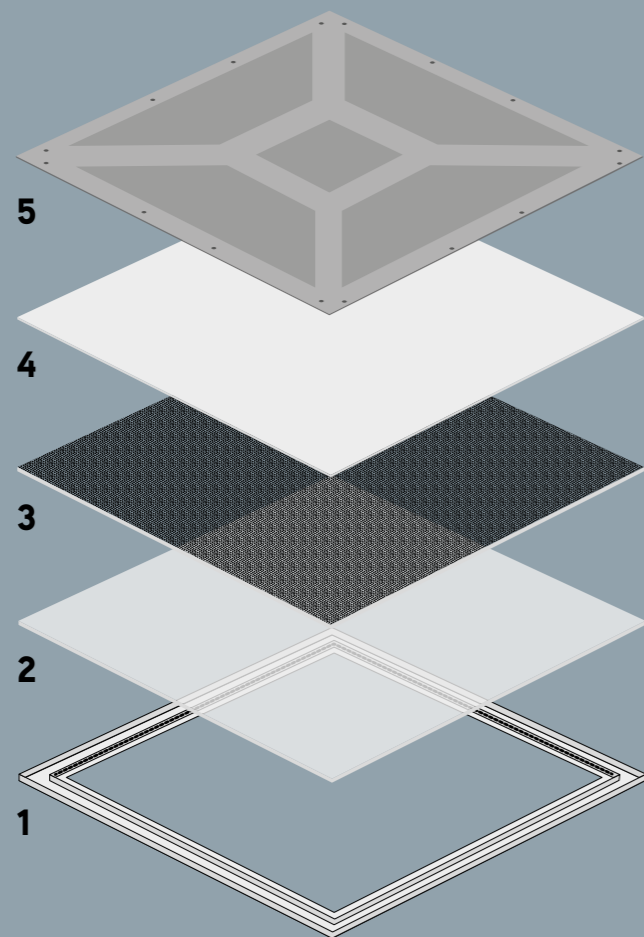

CORNICE ALLUMINIO CON STRISCE LED
 Profilo in alluminio da 290 gr concepito per una migliore dissipazione del calore e dotato di una struttura meccanicamente più stabile. Cornice di alluminio con striscia LED con chip 4014 ad alta efficienza anziché chip 2835 a bassa efficienza luminosa.

ALUMINIUM FRAME WITH LED STRIPS
 Aluminium frame with 290g structure provides a better heat dissipation and a more stable mechanical structure. Led strips high lumen efficiency 4014 chip instead of low efficiency 2835 chip.



DIFFUSORE
 Diffusore in PS da 1,2 mm garantisce l'uniformità dell'emissione ed il mantenimento della temperatura colore (°K). Non usiamo diffusori in PP che ingialliscono in breve tempo modificando la temperatura di colore.

DIFFUSER
 1,2 mm PS diffuser ensures light smoothness and colour temperature maintenance (°K) over time. We do not mount PP diffusers which turn yellowish and modify the colour temperature in a very short time

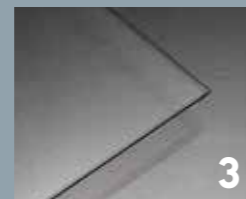

LGP
 In PMMA da 2,8 mm di qualità assicura un alto indice di mantenimento del flusso luminoso anziché PP o PS che causano un decadimento del flusso luminoso nel breve periodo.

LGP
 2,8 mm quality PMMA LGP ensures high luminous flux maintenance over time instead of PP or PS which cause a drastic lumen depreciation.



CARTA RIFLETTENTE
 Foglio PET a doppio rivestimento che migliora l'efficienza luminosa.

PAPER REFLECTOR
 Double coated PET sheet which improves light efficiency.



TAMPONAMENTO DI CHIUSURA

CLOSING SHEET





Apparecchio da incasso/
soffitto/sospensione LED integrato
Corpo in alluminio verniciato
Diffusore in PMMA
Driver incluso

Recessed/ceiling/
Suspension fitting with built-in LED
Painted aluminium body
PMMA diffuser
Driver included

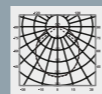
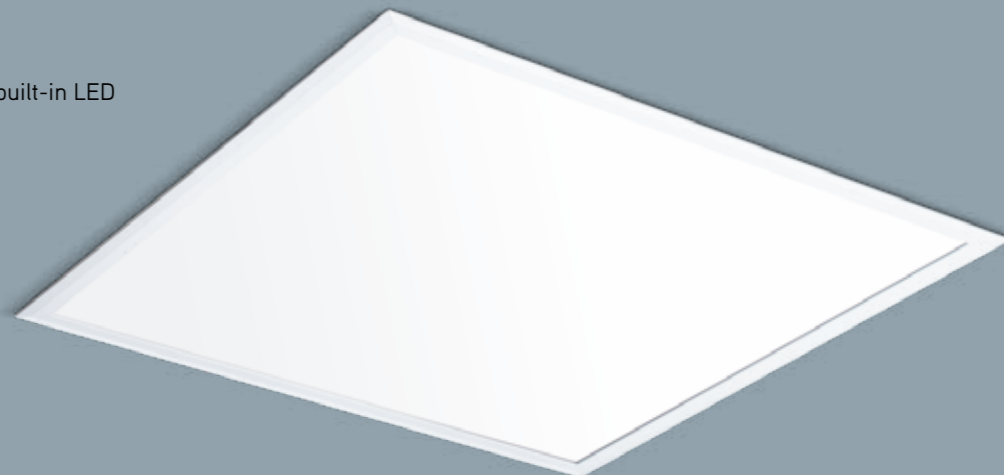
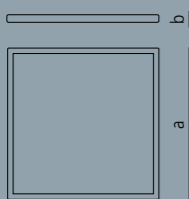

pag. 90

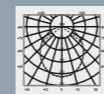

pag. 91

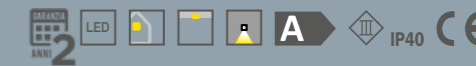

Apparecchio da incasso/
soffitto/sospensione LED integrato
Corpo in alluminio verniciato
Diffusore in PMMA
Driver incluso

Recessed/ceiling/
suspension fitting with built-in LED
Painted aluminium body
PMMA diffuser
Driver included

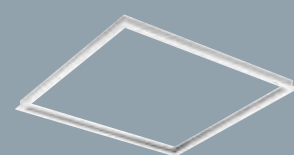
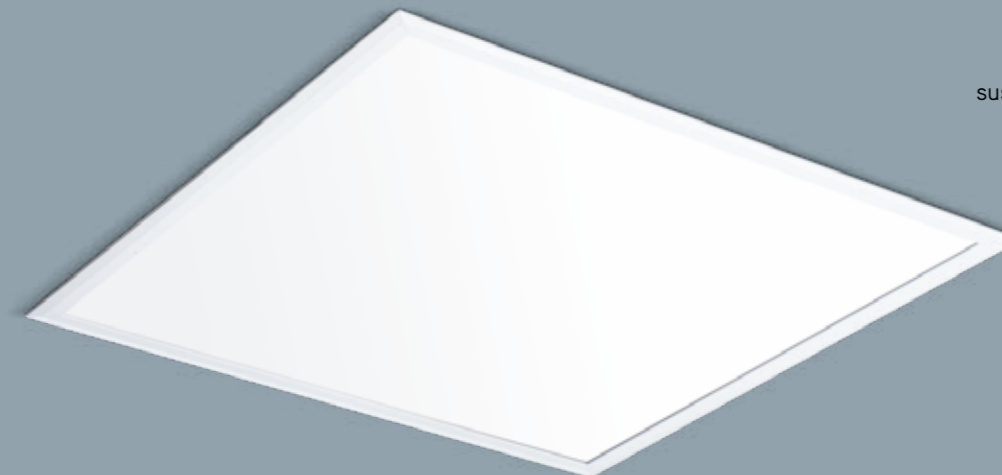
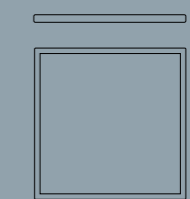

42538
cornice per montaggio cartongesso /
frame for recessed mounting
620x620

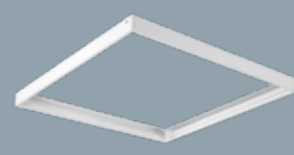

42539
accessorio soffitto H mm. 43 /
ceiling accessory H mm. 43



11622/2
accessorio sospensione H mt. 2 /
suspension accessory H mt. 2



| CODICE / CODE | 40222 | 40224 | 40223 | 40225 |
|--------------------------------|--------------|---------------|--------------|---------------|
| BEAM | 120° | 120° | 120° | 120° |
| COLORE / COLOUR | bianco/white | bianco/white | bianco/white | bianco/white |
| COLORE LUCE / COLOR T | 3000K | 3000K | 4000K | 4000K |
| LUMEN | 3200 | 4000 | 3400 | 4200 |
| CRI | >80 | >80 | >80 | >80 |
| LED | SMD 4014 | SMD 4014 | SMD 4014 | SMD 4014 |
| WATT | 36W | 45W | 36W | 45W |
| SUPPLY | 230V 50/60Hz | 230V 50/60Hz | 230V 50/60Hz | 230V 50/60Hz |
| DRIVER | 900mA/27-42V | 1100mA/27-42V | 900mA/27-42V | 1100mA/27-42V |
| KG | 3,11 | 3,11 | 3,11 | 3,11 |
| PCS | 4 | 4 | 4 | 4 |
| DIMENSIONI / DIMENSIONS | | | | |
| a | 595 | 595 | 595 | 595 |
| b | 9 | 9 | 9 | 9 |

| ACCESSORI | 12549 | Kit emergenza 1/h / Emergency unit 1/h |
|-------------|-------|----------------------------------------------------------------------------------------------|
| ACCESSORIES | 12550 | Kit emergenza 3/h / Emergency unit 3/h |
| | 12835 | Driver dimmerabile (0-10, 1-10V, Dali e Push) / Dimmable driver (0-10, 1-10V, Dali and Push) |

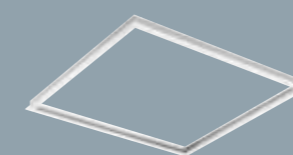

42538
cornice per montaggio cartongesso /
frame for recessed mounting
620x620

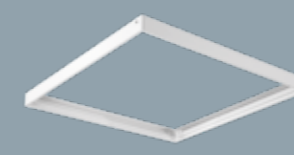

42539
accessorio soffitto H mm. 43 /
ceiling accessory H mm. 43



11622/2
accessorio sospensione H mt. 2 /
suspension accessory H mt. 2



| CODICE / CODE | 40443 | 40444 | 40445 | 40446 |
|--------------------------------|--------------|---------------|--------------|---------------|
| BEAM | 120° | 120° | 120° | 120° |
| COLORE / COLOUR | bianco/white | bianco/white | bianco/white | bianco/white |
| COLORE LUCE / COLOR T | 3000K | 3000K | 4000K | 4000K |
| LUMEN | 2700 | 3300 | 2900 | 3500 |
| CRI | >80 | >80 | >80 | >80 |
| LED | SMD 4014 | SMD 4014 | SMD 4014 | SMD 4014 |
| WATT | 36W | 45W | 36W | 45W |
| SUPPLY | 230V 50/60Hz | 230V 50/60Hz | 230V 50/60Hz | 230V 50/60Hz |
| DRIVER | 900mA/27-42V | 1100mA/27-42V | 900mA/27-42V | 1100mA/27-42V |
| KG | 2,35 | 2,35 | 2,35 | 2,35 |
| PCS | 4 | 4 | 4 | 4 |
| DIMENSIONI / DIMENSIONS | | | | |
| a | 595 | 595 | 595 | 595 |
| b | 9 | 9 | 9 | 9 |

| ACCESSORI | 12549 | Kit emergenza 1/h / Emergency unit 1/h |
|-------------|-------|----------------------------------------------------------------------------------------------|
| ACCESSORIES | 12550 | Kit emergenza 3/h / Emergency unit 3/h |
| | 12835 | Driver dimmerabile (0-10, 1-10V, Dali e Push) / Dimmable driver (0-10, 1-10V, Dali and Push) |



Apparecchio da incasso/soffitto/
sospensione LED integrato
Corpo in alluminio verniciato
Diffusore in PMMA con UGR<19
Driver incluso

Recessed/ceiling/
suspension fitting with built-in LED
Painted aluminium body
PMMA diffuser with UGR<19
Driver included



pag. 91

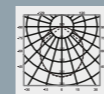

pag. 91

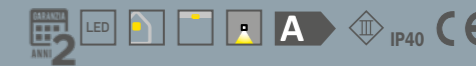

Apparecchio da incasso/
soffitto/sospensione LED integrato
Corpo in alluminio verniciato
Diffusore in PMMA
Driver incluso

Recessed/ceiling/
suspension fitting with built-in LED
Painted aluminium body
PMMA diffuser
Driver included

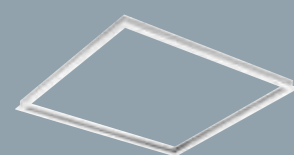
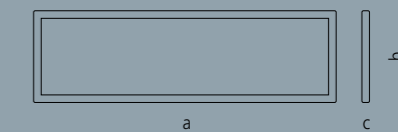
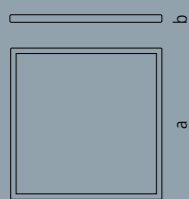

42538
cornice per montaggio cartongesso /
frame for recessed mounting
620x620

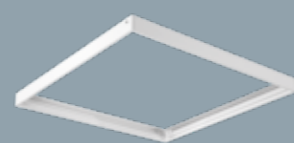

42539
accessorio soffitto H mm. 43 /
ceiling accessory H mm. 43



11622/2
accessorio sospensione H mt. 2 /
suspension accessory H mt. 2



42540
accessorio soffitto H mm 43 /
ceiling accessory H mm 43

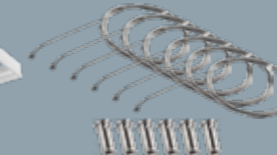

11622/3
accessorio sospensione H mt. 2 /
suspension accessory H mt. 2



| CODICE / CODE | 40447 | 40448 | 40449 | 40450 |
|-------------------------|--------------|---------------|--------------|---------------|
| BEAM | 95° | 95° | 95° | 95° |
| COLORE / COLOUR | bianco/white | bianco/white | bianco/white | bianco/white |
| COLORE LUCE / COLOR T | 3000K | 3000K | 4000K | 4000K |
| LUMEN | 2800 | 3400 | 2900 | 3700 |
| CRI | >80 | >80 | >80 | >80 |
| LED | SMD 4014 | SMD 4014 | SMD 4014 | SMD 4014 |
| WATT | 36W | 45W | 36W | 45W |
| SUPPLY | 230V 50/60Hz | 230V 50/60Hz | 230V 50/60Hz | 230V 50/60Hz |
| DRIVER | 900mA/27-42V | 1100mA/27-42V | 900mA/27-42V | 1100mA/27-42V |
| KG | 2,83 | 2,83 | 2,83 | 2,83 |
| PCS | 4 | 4 | 4 | 4 |
| DIMENSIONI / DIMENSIONS | | | | |
| a | 595 | 595 | 595 | 595 |
| b | 9 | 9 | 9 | 9 |

| ACCESSORI | 12549 | Kit emergenza 1/h / Emergency unit 1/h |
|-------------|-------|----------------------------------------------------------------------------------------------|
| ACCESSORIES | 12550 | Kit emergenza 3/h / Emergency unit 3/h |
| | 12835 | Driver dimmerabile (0-10, 1-10V, Dali e Push) / Dimmable driver (0-10, 1-10V, Dali and Push) |

| CODICE / CODE | 41571 | 41572 | 41561 | 41562 |
|-------------------------|--------------|---------------|--------------|---------------|
| COLORE / COLOUR | bianco/white | bianco/white | bianco/white | bianco/white |
| COLORE LUCE / COLOR T | 3000K | 3000K | 4000K | 4000K |
| LUMEN | 2600 | 3100 | 2800 | 3200 |
| CRI | >80 | >80 | >80 | RA>80 |
| LED | SMD 4014 | SMD 4014 | SMD 4014 | SMD 4014 |
| WATT | 36W | 45W | 36W | 45W |
| SUPPLY | 230V 50/60Hz | 230V 50/60Hz | 230V 50/60Hz | 230V 50/60Hz |
| DRIVER | 900mA/27-42V | 1100mA/27-42V | 900mA/27-42V | 1100mA/27-42V |
| KG | 2,55 | 2,55 | 2,55 | 2,55 |
| PCS | 4 | 4 | 4 | 4 |
| DIMENSIONI / DIMENSIONS | | | | |
| a | 1195 | 1195 | 1195 | 1195 |
| b | 295 | 295 | 295 | 295 |
| c | 9 | 9 | 9 | 9 |

| ACCESSORI | 12549 | Kit emergenza 1/h / Emergency unit 1/h |
|-------------|-------|----------------------------------------------------------------------------------------------|
| ACCESSORIES | 12550 | Kit emergenza 3/h / Emergency unit 3/h |
| | 12835 | Driver dimmerabile (0-10, 1-10V, Dali e Push) / Dimmable driver (0-10, 1-10V, Dali and Push) |



appliques PLAFONNIÈRE

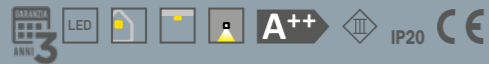

Apparecchio da soffitto LED integrato
Corpo in alluminio verniciato
Diffusore in PMMA
Driver incluso

Ceiling fitting
Painted aluminium body
PMMA diffuser
Driver included



pag. 90

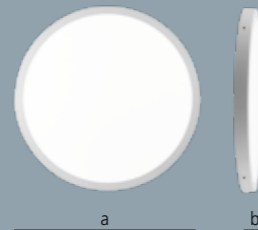

| CODICE / CODE | 41585 | 41586 |
|--------------------------------|---------------|---------------|
| BEAM | 120° | 120° |
| COLORE / COLOUR | bianco/white | bianco/white |
| COLORE LUCE / COLOR T | 3000K | 4000K |
| LUMEN | 4480 | 4889 |
| CRI | >80 | >80 |
| LED | Epistar | Epistar |
| WATT | 48W | 48W |
| PF | 0,9 | 0,9 |
| SUPPLY | 230V 50/60Hz | 230V 50/60Hz |
| DRIVER | 1200mA/30-42V | 1200mA/30-42V |
| KG | 3,4 | 3,4 |
| PCS | 2 | 2 |
| DIMENSIONI / DIMENSIONS | | |
| a | Ø600 | Ø600 |
| b | 40 | 40 |

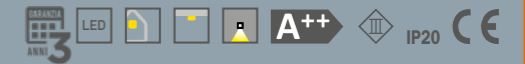

Apparecchio da soffitto LED integrato
Corpo in alluminio verniciato
Diffusore in PMMA
Driver incluso

Ceiling fitting
Painted aluminium body
PMMA diffuser
Driver included

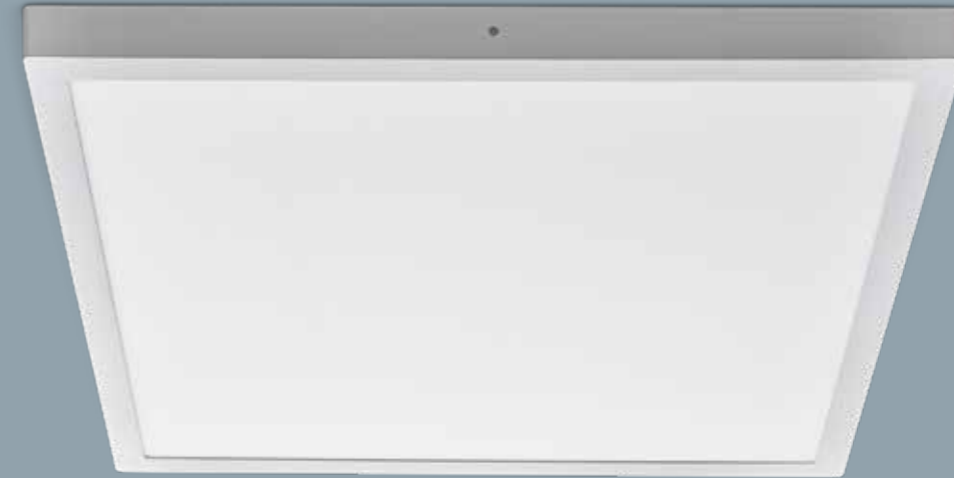

| CODICE / CODE | 41595 | 41596 |
|--------------------------------|---------------|---------------|
| BEAM | 120° | 120° |
| COLORE / COLOUR | bianco/white | bianco/white |
| COLORE LUCE / COLOR T | 3000K | 4000K |
| RATED LUMEN | 4480 | 4800 |
| LUMEN | 6240 | 6720 |
| CRI | >80 | >80 |
| LED | Epistar | Epistar |
| WATT | 48W | 48W |
| PF | 0,9 | 0,9 |
| SUPPLY | 230V 50/60Hz | 230V 50/60Hz |
| DRIVER | 1200mA/30-42V | 1200mA/30-42V |
| KG | 5,0 | 5,0 |
| PCS | 4 | 4 |
| DIMENSIONI / DIMENSIONS | | |
| a | 600 | 600 |
| b | 40 | 40 |

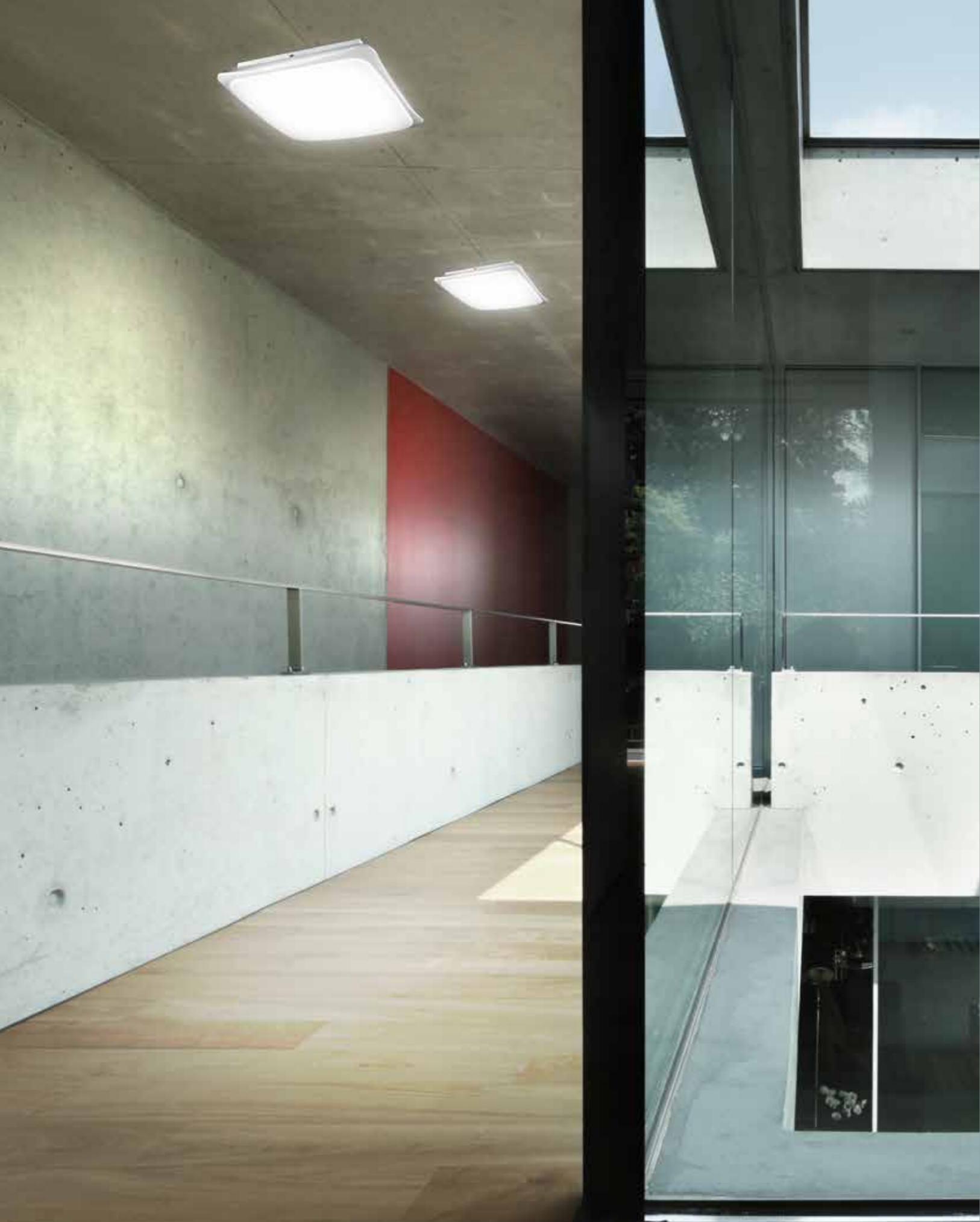

Apparecchio soffitto
Corpo in acciaio
Diffusore in PMMA

Ceiling fitting
Steel body
PMMA diffuser

ISIDE



| | |
|--------------------------------|-----------------|
| CODICE / CODE | 40378 |
| COLORE / COLOUR | bianco white |
| COLORE LUCE / COLOR T | 3000K |
| LUMEN | 4000 |
| CRI | >80 |
| LED | Sanan |
| WATT | 50W |
| PF | 0,9 |
| SUPPLY | 230V 50/60Hz |
| KG | 2 |
| PCS | 2 |
| DIMENSIONI / DIMENSIONS | |
| a | 510 |
| b | 100 |



Apparecchio a soffitto
Anello in alluminio
Schermo in PC opale

Ceiling fitting
Aluminium ring
Opal PC screen

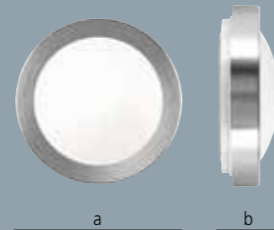

| CODICE / CODE | 43439 | 40439 | 43440 | 40440 |
|-------------------------|--------------|---------------------|--------------|---------------------|
| COLORE / COLOUR | bianco/white | alluminio/aluminium | bianco/white | alluminio/aluminium |
| LAMP | E27 | E27 | E27 | E27 |
| WATT | Max 20W | Max 20W | Max 2x20W | Max 2x20W |
| SUPPLY | 230V 50/60Hz | 230V 50/60Hz | 230V 50/60Hz | 230V 50/60Hz |
| KG | 0,48 | 0,48 | 0,48 | 0,48 |
| PCS | 10 | 10 | 10 | 10 |
| DIMENSIONI / DIMENSIONS | | | | |
| a | 270 | 270 | 350 | 350 |
| b | 97 | 97 | 97 | 97 |



Apparecchio a soffitto
Anello in alluminio
Schermo in PC opale

Ceiling fitting
Aluminium ring
Opal PC screen

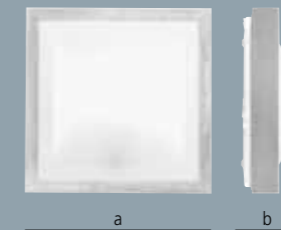

| CODICE / CODE | 43441 | 40441 | 43442 | 40442 |
|-------------------------|--------------|---------------------|--------------|---------------------|
| COLORE / COLOUR | bianco/white | alluminio/aluminium | bianco/white | alluminio/aluminium |
| LAMP | E27 | E27 | E27 | E27 |
| WATT | Max 20W | Max 20W | Max 3x20W | Max 3x20W |
| SUPPLY | 230V 50/60Hz | 230V 50/60Hz | 230V 50/60Hz | 230V 50/60Hz |
| KG | 0,85 | 0,85 | 1,3 | 1,3 |
| PCS | 10 | 10 | 5 | 5 |
| DIMENSIONI / DIMENSIONS | | | | |
| a | 270 | 270 | 370 | 370 |
| b | 85 | 85 | 85 | 85 |



Apparecchio a soffitto
Corpo in metallo
Schermo in vetro satinato

Ceiling fitting
Metal body
Frosted glass screen

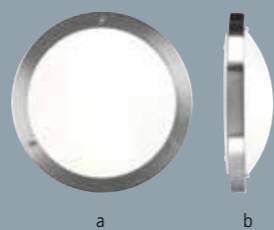

| CODICE / CODE | 43544 | 41544 | 43545 | 41545 |
|-------------------------|-----------------|---------------|-----------------|---------------|
| COLORE / COLOUR | bianco white | nikel matt | bianco white | nikel matt |
| LAMP | E27 | E27 | E27 | E27 |
| WATT | Max 2x28W | Max 2x28W | Max 2x52W | Max 2x52W |
| SUPPLY | 230V 50/60Hz | 230V 50/60Hz | 230V 50/60Hz | 230V 50/60Hz |
| KG | 1,5 | 1,5 | 2,8 | 2,8 |
| PCS | 10 | 10 | 5 | 5 |
| DIMENSIONI / DIMENSIONS | | | | |
| a | Ø300 | Ø300 | Ø400 | Ø400 |
| b | 90 | 90 | 110 | 110 |

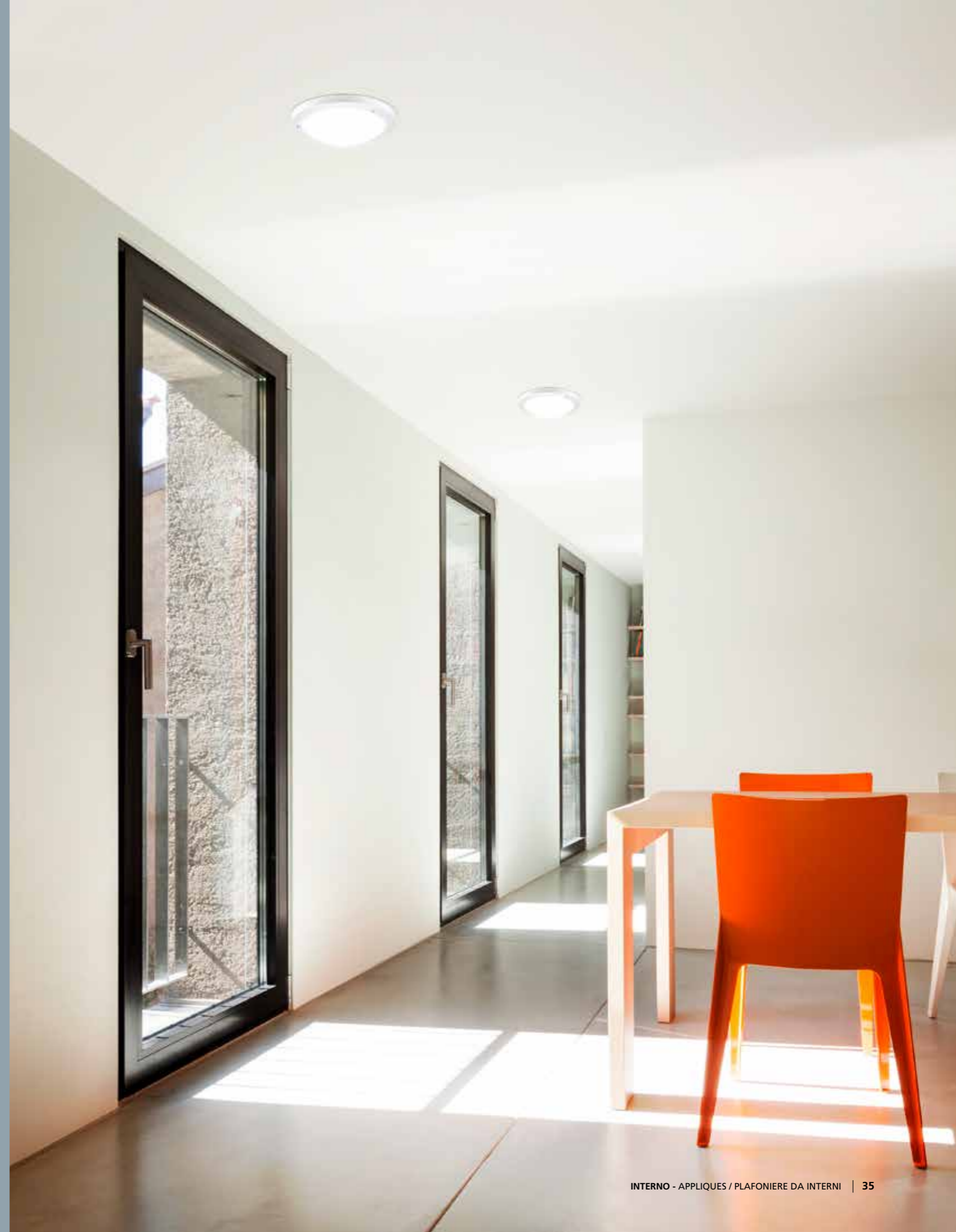

Apparecchio a soffitto
Corpo in materiale plastico
Schermo in PC opale

Ceiling fitting
Plastic body
Opal PC screen

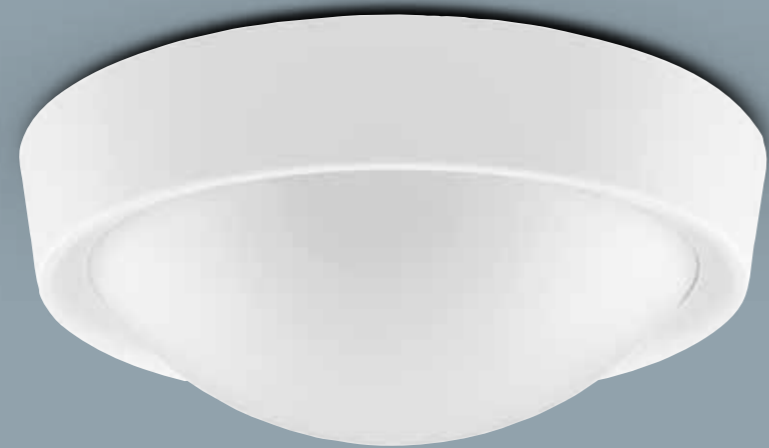

| CODICE / CODE | 40366 | 40365 |
|-------------------------|-----------------|-------------------|
| COLORE / COLOUR | bianco white | argento silver |
| LAMP | E27 | E27 |
| WATT | Max 15W | Max 15W |
| SUPPLY | 230V 50/60Hz | 230V 50/60Hz |
| KG | 0,4 | 0,4 |
| PCS | 10 | 10 |
| DIMENSIONI / DIMENSIONS | | |
| a | Ø270 | Ø270 |
| b | 100 | 100 |



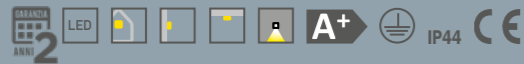

Apparecchio a parete
LED integrato
Corpo in metallo cromato
Diffusore in PC opale

Built-in LED
wall fitting
Chromed metal body
Opal PC diffuser

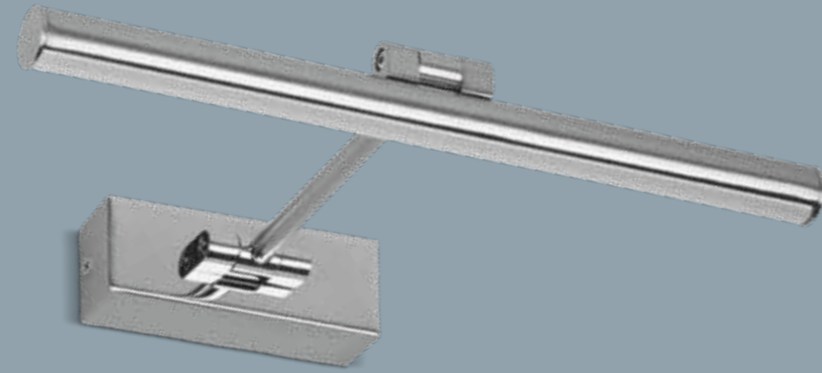

| CODICE / CODE | 42612 | 42613 | 42614 |
|-------------------------|-----------------|-----------------|-----------------|
| COLORE / COLOUR | cromo/chrome | cromo/chrome | cromo/chrome |
| COLORE LUCE / COLOR T | 3000K | 3000K | 3000K |
| LUMEN | 500 | 750 | 1000 |
| CRI | >80 | >80 | >80 |
| LED | Sanan | Sanan | Sanan |
| WATT | 8W | 12W | 16W |
| PF | >0,5 | >0,5 | >0,5 |
| SUPPLY | 220mA 18-36V | 350mA 24-45V | 350mA 24-45V |
| KG | | | |
| PCS | 12 | 12 | 12 |
| DIMENSIONI / DIMENSIONS | | | |
| a | 300 | 450 | 600 |
| b | 40 | 45 | 45 |
| c | 220 | 225 | 225 |



Apparecchio a parete
LED integrato
Corpo in metallo cromato
Diffusore in PC opale

Built-in LED
wall fitting
Chromed metal body
Opal PC diffuser

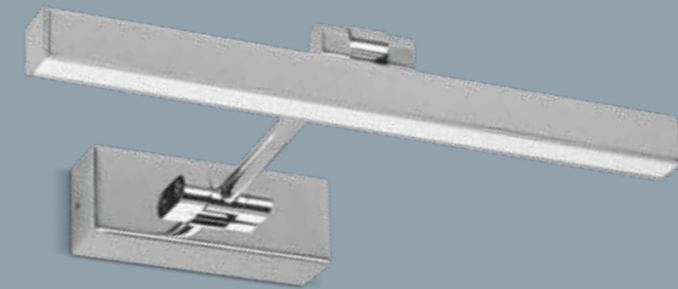

| CODICE / CODE | 42609 | 42610 | 42611 |
|-------------------------|-----------------|-----------------|-----------------|
| COLORE / COLOUR | cromo/chrome | cromo/chrome | cromo/chrome |
| COLORE LUCE / COLOR T | 3000K | 3000K | 3000K |
| LUMEN | 500 | 750 | 1000 |
| CRI | >80 | >80 | >80 |
| LED | Sanan | Sanan | Sanan |
| WATT | 8W | 12W | 16W |
| PF | >0,5 | >0,5 | >0,5 |
| SUPPLY | 220mA 18-36V | 350mA 24-45V | 350mA 24-45V |
| KG | | | |
| PCS | 12 | 12 | 12 |
| DIMENSIONI / DIMENSIONS | | | |
| a | 300 | 450 | 600 |
| b | 40 | 45 | 45 |
| c | 220 | 225 | 225 |



Apparecchio LED integrato
Corpo in materiale plastico
Diffusore in PC opale
Driver integrato

Built-in LED fitting
Plastic body
Opal PC diffuser
Built-in driver

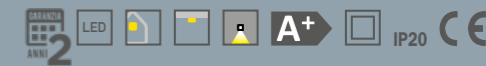

Apparecchio LED integrato
Corpo in materiale plastico
Diffusore in PC opale
Driver integrato

Built-in LED fitting
Plastic body
Opal PC diffuser
Built-in driver

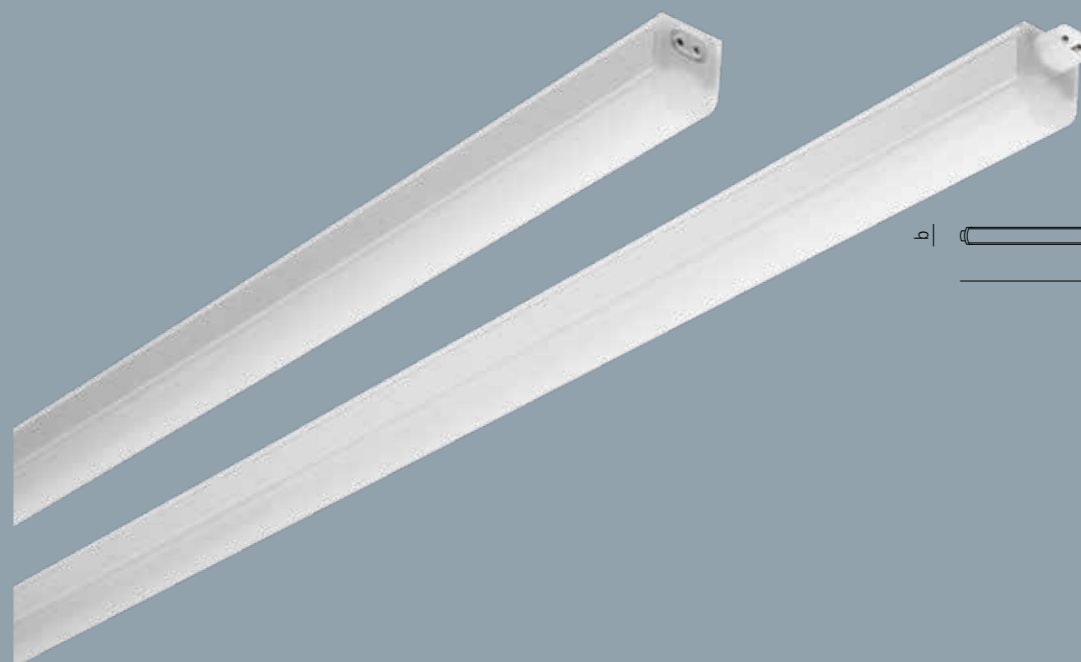
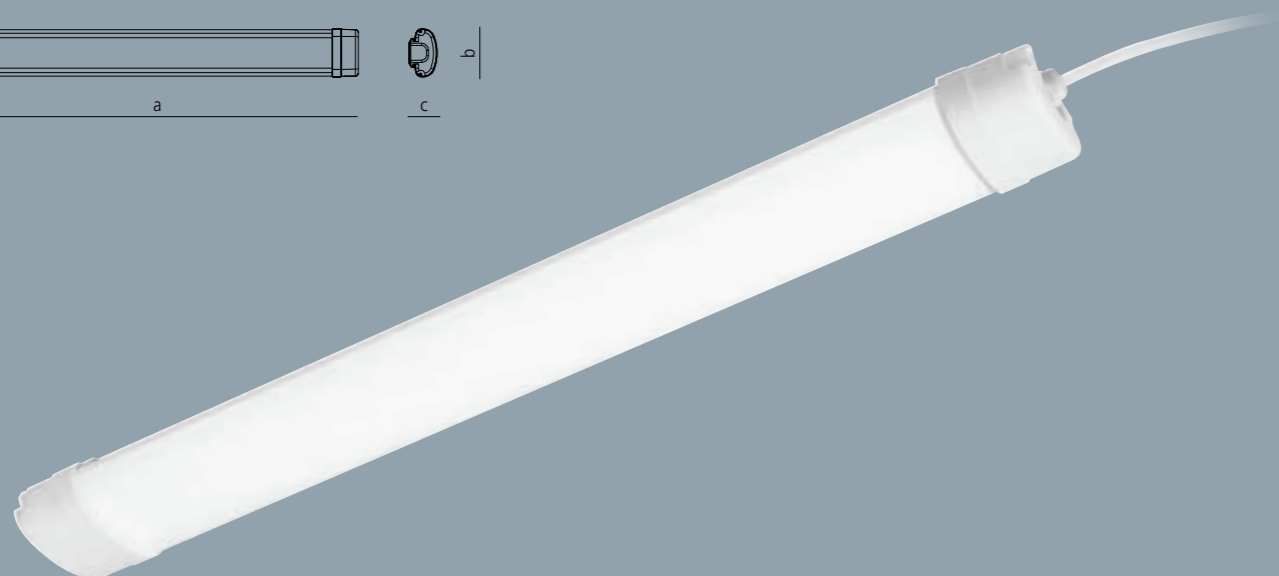
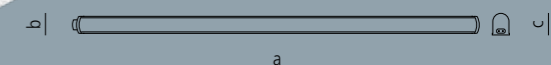

9W max 30 pcs
14W max 20 pcs
18W max 15 pcs
24W max 10 pcs



| CODICE / CODE | 40431 | 40432 | 40433 |
|--------------------------------|--------------|--------------|--------------|
| BEAM | 180° | 180° | 180° |
| COLORE / COLOUR | bianco/white | bianco/white | bianco/white |
| COLORE LUCE / COLOR T | 4000K | 4000K | 4000K |
| LUMEN | 1656 | 3312 | 4000 |
| CRI | >80 | >80 | >80 |
| LED | Epistar | Epistar | Epistar |
| WATT | 18W | 36W | 45W |
| PF | 0.95 | 0.95 | 0.90 |
| SUPPLY | 230V 50/60Hz | 230V 50/60Hz | 230V 50/60Hz |
| KG | 0.35 | 0.70 | 0.95 |
| PCS | 10 | 10 | 10 |
| DIMENSIONI / DIMENSIONS | | | |
| a | 600 | 1200 | 1500 |
| b | 76 | 76 | 76 |
| c | 46 | 46 | 46 |

| CODICE / CODE | 42543 | 42544 | 42545 | 42546 | 42547 | 42548 | 42549 | 42550 | 42551 | 42552 | 42553 | 42554 |
|--------------------------------|-----------------|-----------------|-----------------|-----------------|-----------------|-----------------|-----------------|-----------------|-----------------|-----------------|-----------------|-----------------|
| COLORE / COLOUR | bianco white | bianco white | bianco white | bianco white | bianco white | bianco white | bianco white | bianco white | bianco white | bianco white | bianco white | bianco white |
| COLORE LUCE / COLOR T | 3000K | 4000K | 6000K | 3000K | 4000K | 6000K | 3000K | 4000K | 6000K | 3000K | 4000K | 6000K |
| LUMEN | 810 | 855 | 893 | 1260 | 1300 | 1318 | 1620 | 1680 | 1740 | 2160 | 2178 | 2230 |
| CRI | >80 | >80 | >80 | >80 | >80 | >80 | >80 | >80 | >80 | >80 | >80 | >80 |
| LED | Sanan | Sanan | Sanan | Sanan | Sanan | Sanan | Sanan | Sanan | Sanan | Sanan | Sanan | Sanan |
| WATT | 9W | 9W | 9W | 14W | 14W | 14W | 18W | 18W | 18W | 24W | 24W | 24W |
| PF | >0,5 | >0,5 | >0,5 | >0,5 | >0,5 | >0,5 | >0,5 | >0,5 | >0,5 | >0,5 | >0,5 | >0,5 |
| SUPPLY | 230V 50/60Hz | 230V 50/60Hz | 230V 50/60Hz | 230V 50/60Hz | 230V 50/60Hz | 230V 50/60Hz | 230V 50/60Hz | 230V 50/60Hz | 230V 50/60Hz | 230V 50/60Hz | 230V 50/60Hz | 230V 50/60Hz |
| KG | 0.121 | 0.121 | 0.121 | 0.161 | 0.161 | 0.161 | 0.235 | 0.235 | 0.235 | 0.315 | 0.315 | 0.315 |
| PCS | 30 | 30 | 30 | 30 | 30 | 30 | 30 | 30 | 30 | 30 | 30 | 30 |
| DIMENSIONI / DIMENSIONS | | | | | | | | | | | | |
| a | 585 | 585 | 585 | 885 | 885 | 885 | 1185 | 1185 | 1185 | 1485 | 1485 | 1485 |
| b | 22 | 22 | 22 | 22 | 22 | 22 | 22 | 22 | 22 | 22 | 22 | 22 |
| c | 30 | 30 | 30 | 30 | 30 | 30 | 30 | 30 | 30 | 30 | 30 | 30 |



Apparecchio LED integrato
Corpo in materiale plastico
Diffusore in PC opale
Driver integrato

Built-in LED fitting
Plastic body
Opal PC diffuser
Built-in driver

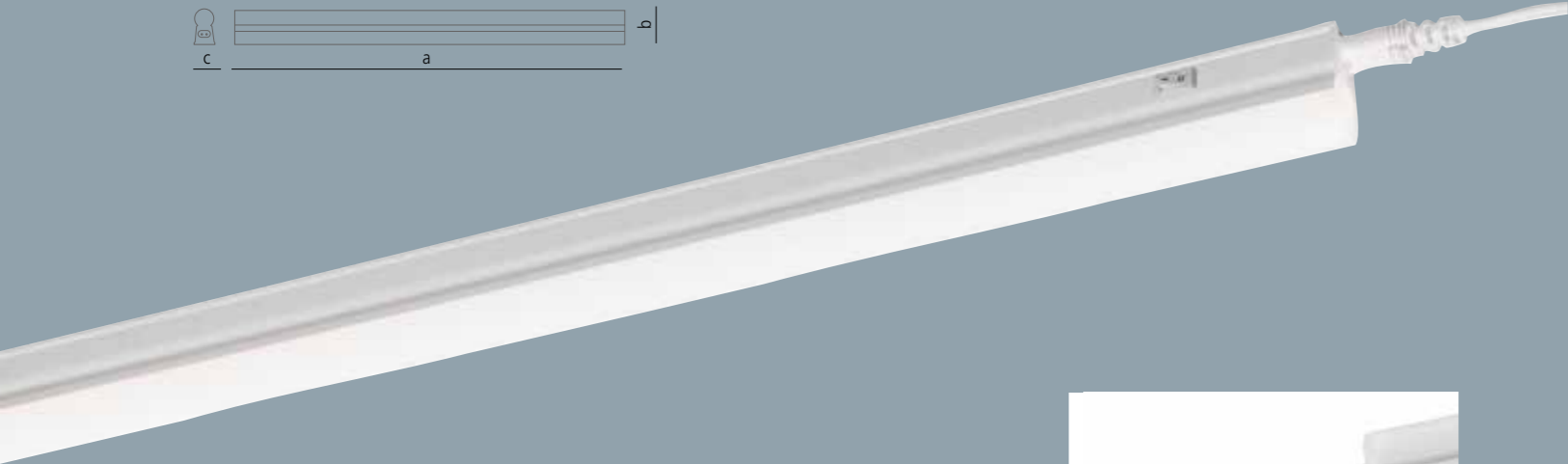
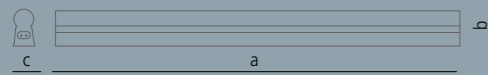

7W max 15 pcs
10W max 10 pcs
14W max 8 pcs



| CODICE / CODE | 40284 | 40287 | 40285 | 40288 | 40286 | 40289 |
|--------------------------------|--------------|--------------|--------------|--------------|--------------|--------------|
| COLORE / COLOUR | bianco/white | bianco/white | bianco/white | bianco/white | bianco/white | bianco/white |
| COLORE LUCE / COLOR T | 3000K | 4000K | 3000K | 4000K | 3000K | 4000K |
| LUMEN | 650 | 700 | 950 | 1000 | 1350 | 1400 |
| CRI | >80 | >80 | >80 | >80 | >80 | >80 |
| LED | Sanan | Sanan | Sanan | Sanan | Sanan | Sanan |
| WATT | 7W | 7W | 10W | 10W | 14W | 14W |
| PF | 0,9 | 0,9 | 0,9 | 0,9 | 0,9 | 0,9 |
| SUPPLY | 230V 50/60Hz | 230V 50/60Hz | 230V 50/60Hz | 230V 50/60Hz | 230V 50/60Hz | 230V 50/60Hz |
| KG | 0,12 | 0,12 | 0,16 | 0,16 | 0,20 | 0,20 |
| PCS | 25 | 25 | 25 | 25 | 25 | 25 |
| DIMENSIONI / DIMENSIONS | | | | | | |
| a | 582 | 582 | 882 | 882 | 1182 | 1182 |
| b | 36 | 36 | 36 | 36 | 36 | 36 |
| c | 23 | 23 | 23 | 23 | 23 | 23 |



Apparecchio LED integrato
Corpo in materiale plastico
Diffusore in PC opale
Driver integrato

Built-in LED fitting
Plastic body
Opal PC diffuser
Built-in driver

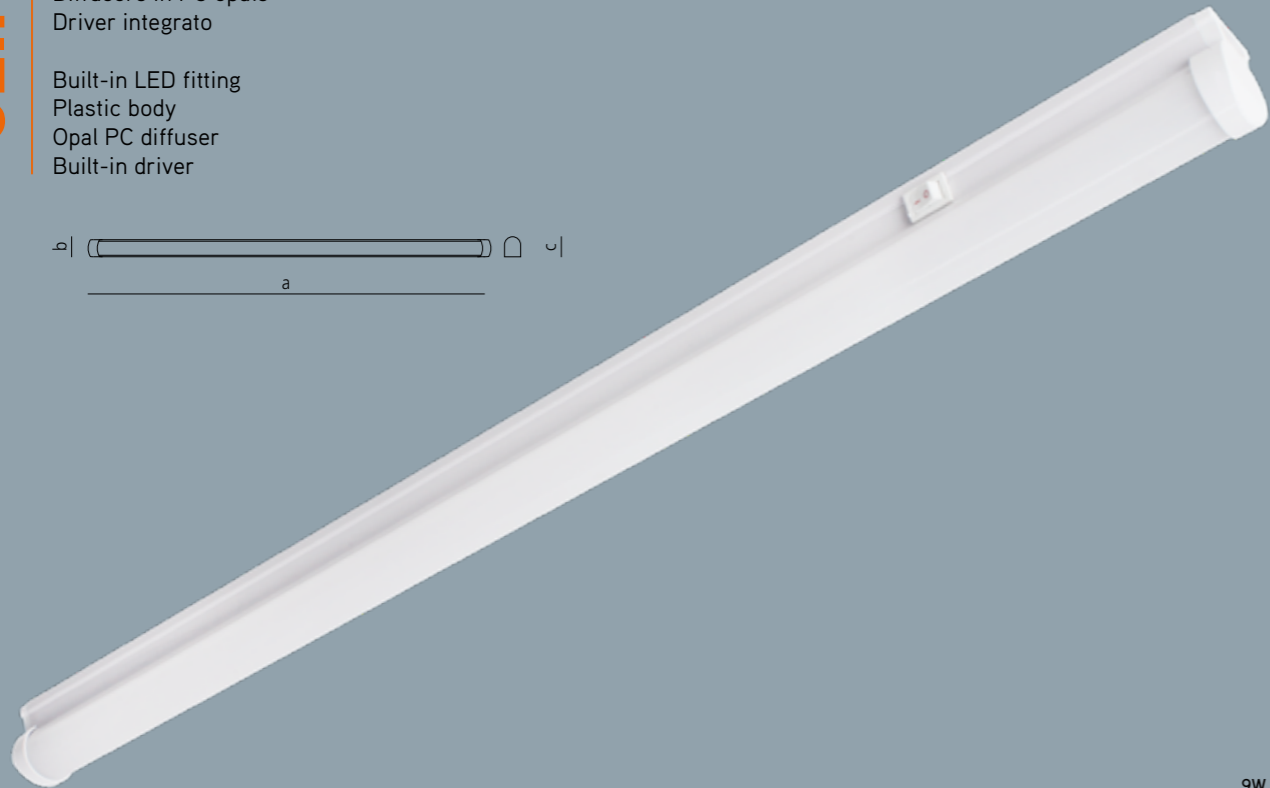
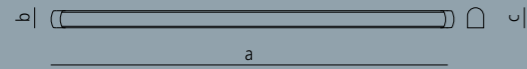

9W max 30 pcs
18W max 15 pcs
24W max 10 pcs

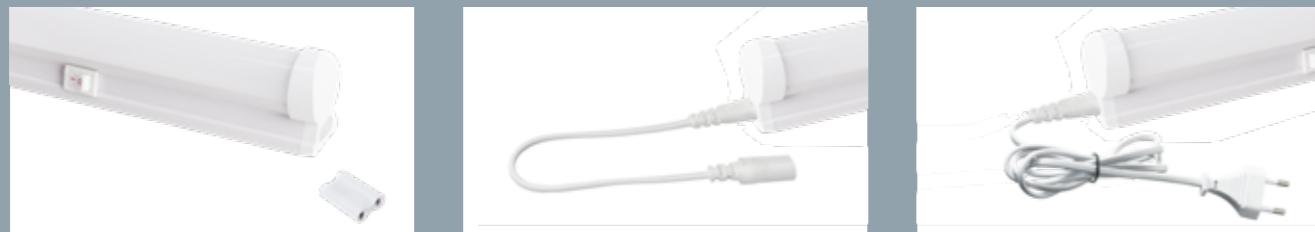

| CODICE / CODE | 42555 | 42556 | 42557 | 42558 | 42559 | 42560 | 42561 | 42562 | 42563 |
|-------------------------|-----------------|-----------------|-----------------|-----------------|-----------------|-----------------|-----------------|-----------------|-----------------|
| COLORE / COLOUR | bianco white | bianco white | bianco white | bianco white | bianco white | bianco white | bianco white | bianco white | bianco white |
| COLORE LUCE / COLOR T | 3000K | 4000K | 6000K | 3000K | 4000K | 6000K | 3000K | 4000K | 6000K |
| LUMEN | 810 | 855 | 893 | 1620 | 1680 | 1740 | 2160 | 2178 | 2230 |
| CRI | >80 | >80 | >80 | >80 | >80 | >80 | >80 | >80 | >80 |
| LED | Sanan | Sanan | Sanan | Sanan | Sanan | Sanan | Sanan | Sanan | Sanan |
| WATT | 9W | 9W | 9W | 18W | 18W | 18W | 24W | 24W | 24W |
| PF | >0,5 | >0,5 | >0,5 | >0,5 | >0,5 | >0,5 | >0,5 | >0,5 | >0,5 |
| SUPPLY | 230V 50/60Hz | 230V 50/60Hz | 230V 50/60Hz | 230V 50/60Hz | 230V 50/60Hz | 230V 50/60Hz | 230V 50/60Hz | 230V 50/60Hz | 230V 50/60Hz |
| KG | 0,125 | 0,125 | 0,125 | 0,240 | 0,240 | 0,240 | 0,320 | 0,320 | 0,320 |
| PCS | 25 | 25 | 25 | 25 | 25 | 25 | 25 | 25 | 25 |
| DIMENSIONI / DIMENSIONS | | | | | | | | | |
| a | 580 | 580 | 580 | 1180 | 1180 | 1180 | 1485 | 1485 | 1485 |
| b | 25 | 25 | 25 | 25 | 25 | 25 | 25 | 25 | 25 |
| c | 36 | 36 | 36 | 36 | 36 | 36 | 36 | 36 | 36 |



Apparecchio LED integrato
Corpo in materiale plastico
Diffusore in PC opale
Driver integrato

Built-in LED fitting
Plastic body
Opal PC diffuser
Built-in driver

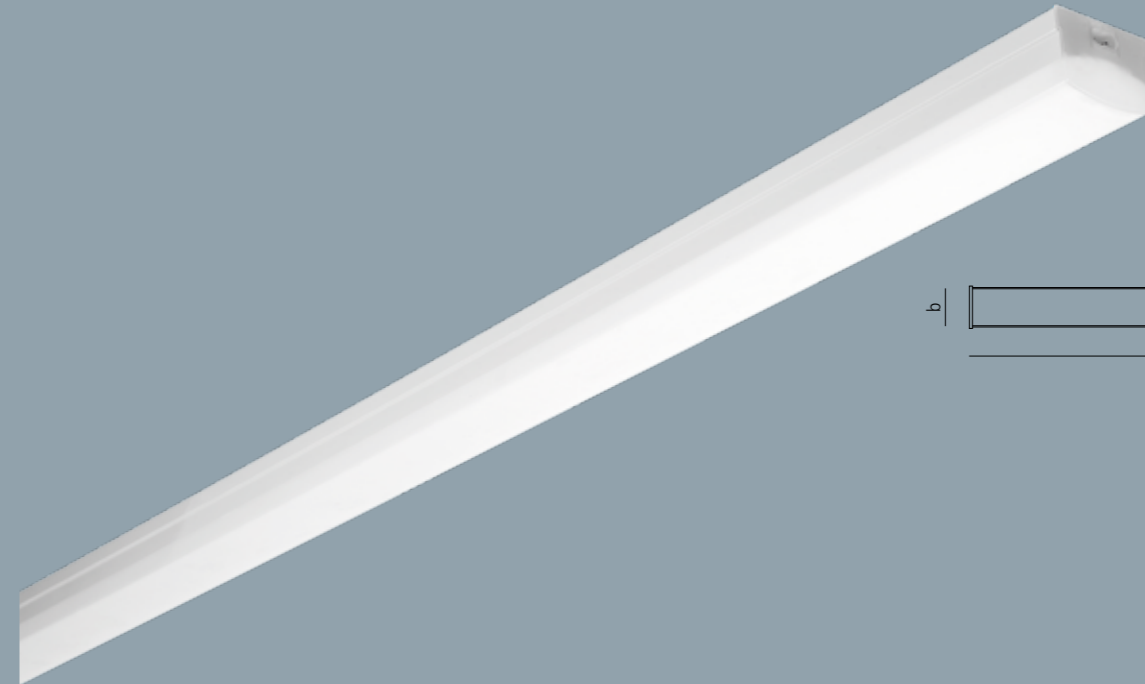
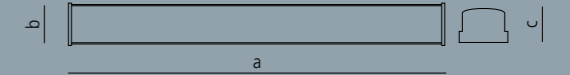

18W max 15 pcs
36W max 8 pcs

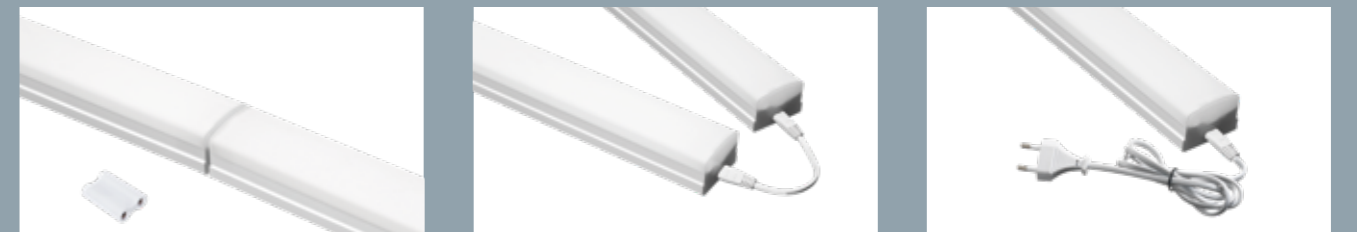

| CODICE / CODE | 42564 | 42565 | 42566 | 42567 | 42568 | 42569 |
|-------------------------|--------------|--------------|--------------|--------------|--------------|--------------|
| COLORE / COLOUR | bianco/white | bianco/white | bianco/white | bianco/white | bianco/white | bianco/white |
| COLORE LUCE / COLOR T | 3000K | 4000K | 6000K | 3000K | 4000K | 6000K |
| LUMEN | 1494 | 1530 | 1570 | 2988 | 3060 | 3143 |
| CRI | >80 | >80 | >80 | >80 | >80 | >80 |
| LED | Sanan | Sanan | Sanan | Sanan | Sanan | Sanan |
| WATT | 18W | 18W | 18W | 36W | 36W | 36W |
| PF | 0,5 | 0,5 | 0,5 | 0,5 | 0,5 | 0,5 |
| SUPPLY | 230V 50/60Hz | 230V 50/60Hz | 230V 50/60Hz | 230V 50/60Hz | 230V 50/60Hz | 230V 50/60Hz |
| KG | 0,265 | 0,265 | 0,265 | 0,545 | 0,545 | 0,545 |
| PCS | 15 | 15 | 15 | 8 | 8 | 8 |
| DIMENSIONI / DIMENSIONS | | | | | | |
| a | 600 | 600 | 600 | 1200 | 1200 | 1200 |
| b | 60 | 60 | 60 | 60 | 60 | 60 |
| c | 40 | 40 | 40 | 40 | 40 | 40 |

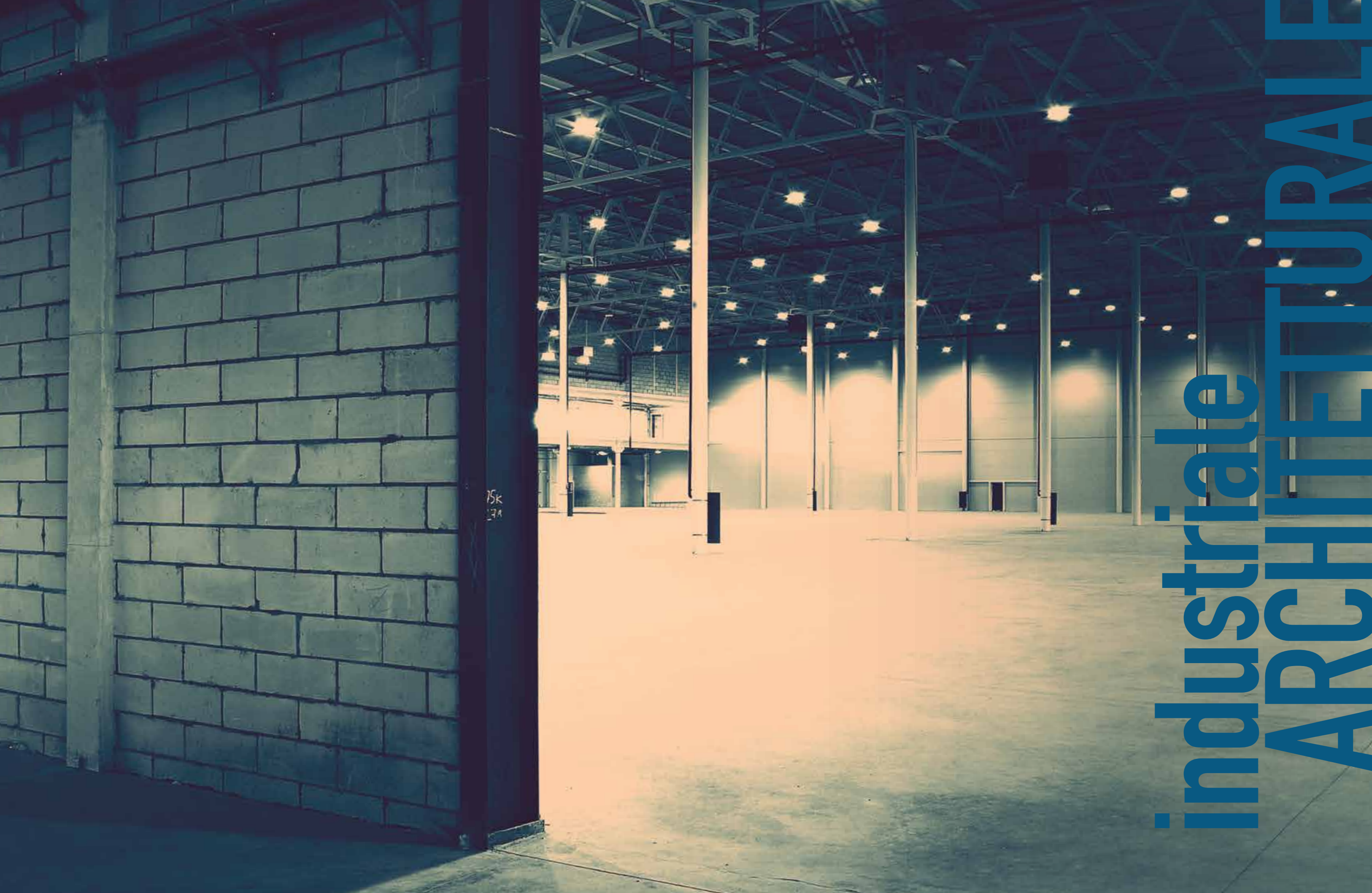

75k
271

industriale ARCHITETTURA



pag. 85

Proiettore con LED LG alta efficienza e driver Meanwell
 Tecnologia avanzata per la gestione dissipazione calore
 Riflettore ad alta efficienza
 Schermo in vetro temperato
 Staffa orientabile
 Soluzione risparmio energetico
 Sostituzione apparecchi Ioduri metallici

Projector with built-in high efficiency LG LED and Meanwell Driver
 Advanced heat management technology
 High efficiency reflector
 Tempered glass screen
 Solid adjustability of the bracket
 Perfect energy saving solution replace HID fittings
 Driver included

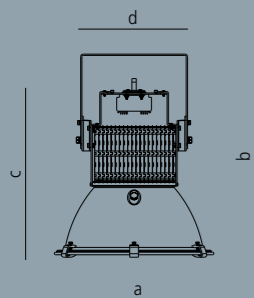
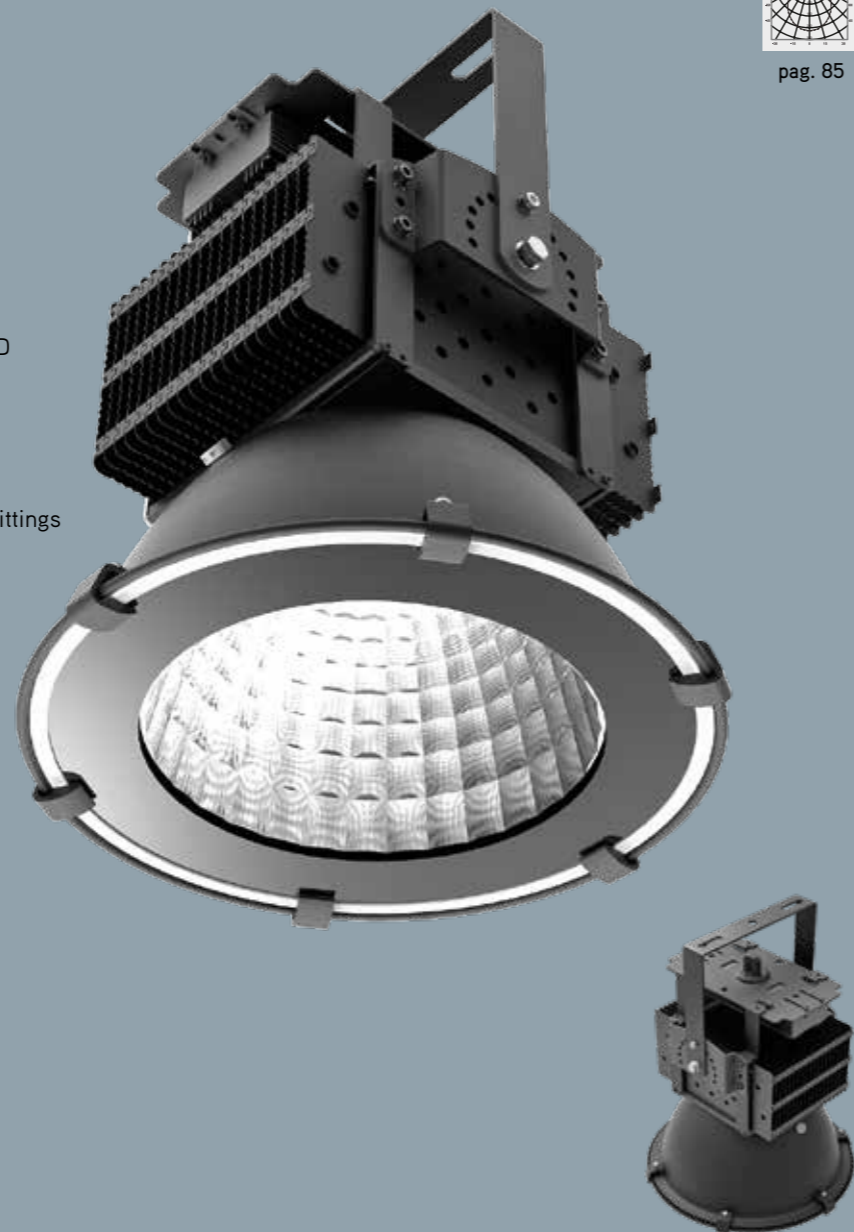

| CODICE / CODE | 41563 | 41564 | 41565 | 41566 | 41567 | 41568 | 41569 | 41570 |
|--------------------------------|--------------|--------------|--------------|--------------|--------------|--------------|--------------|--------------|
| BEAM | 60° | 60° | 90° | 90° | 60° | 60° | 90° | 90° |
| COLORE / COLOUR | nero/black | nero/black | nero/black | nero/black | nero/black | nero/black | nero/black | nero/black |
| COLORE LUCE / COLOR T | 4000K | 6000K | 4000K | 6000K | 4000K | 6000K | 4000K | 6000K |
| LUMEN | 11000 | 11640 | 11000 | 11640 | 14000 | 15050 | 14000 | 15050 |
| CRI | >80 | >80 | >80 | >80 | >80 | >80 | >80 | >80 |
| LED | LG3030 | LG3030 | LG3030 | LG3030 | LG3030 | LG3030 | LG3030 | LG3030 |
| WATT | 120W | 120W | 120W | 120W | 150W | 150W | 150W | 150W |
| PF | 0,9 | 0,9 | 0,9 | 0,9 | 0,9 | 0,9 | 0,9 | 0,9 |
| SUPPLY | 230V 50/60Hz | 230V 50/60Hz | 230V 50/60Hz | 230V 50/60Hz | 230V 50/60Hz | 230V 50/60Hz | 230V 50/60Hz | 230V 50/60Hz |
| KG | 5,3 | 5,3 | 5,3 | 5,3 | 6,07 | 6,07 | 6,07 | 6,07 |
| PCS | 1 | 1 | 1 | 1 | 1 | 1 | 1 | 1 |
| DIMENSIONI / DIMENSIONS | | | | | | | | |
| a | 374 | 374 | 374 | 374 | 374 | 374 | 374 | 374 |
| b | 459 | 459 | 459 | 459 | 467 | 467 | 467 | 467 |
| c | 410 | 410 | 410 | 410 | 410 | 410 | 410 | 410 |
| d | 246 | 246 | 246 | 246 | 266 | 266 | 266 | 266 |



STAGNA IP65



Corpo in ABS e diffusore in PS
 Base struttura interna in metallo
 600mm 4 clips di chiusura
 1200mm 10 clips di chiusura
 1500mm 12 clips di chiusura
 Collegamento diretto tensione di rete
 Solo per tubi LED 230V

ABS body + PS diffuser
 Internal tray in plated iron
 600mm 4 latches
 1200mm 10 latches
 1500mm 12 latches
 Direct connection to mains voltage
 Only for LED tubes 230V

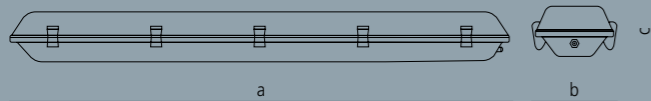
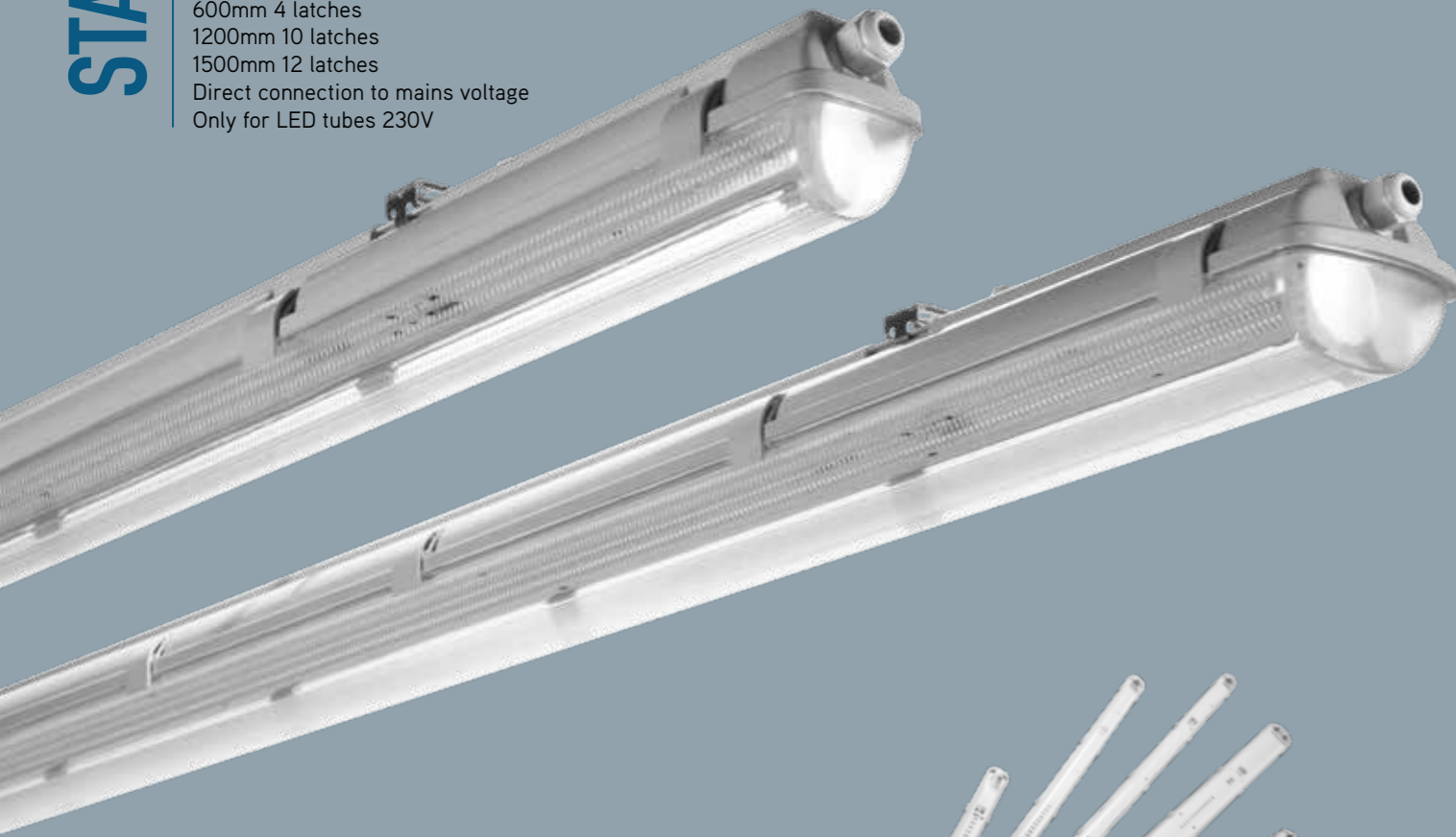

| CODICE / CODE | 41555 | 41556 | 41557 | 41558 | 41559 | 41560 |
|--------------------------------|-------|-------|-------|-------|-------|-------|
| | Mono | Mono | Mono | Bi | Bi | Bi |
| KG | 0,53 | 0,90 | 1,19 | 0,67 | 1,22 | 1,57 |
| PCS | 12 | 12 | 8 | 8 | 4 | 4 |
| DIMENSIONI / DIMENSIONS | | | | | | |
| a | 655 | 1263 | 1564 | 655 | 1263 | 1564 |
| b | 66 | 66 | 66 | 106 | 106 | 106 |
| c | 90 | 90 | 90 | 90 | 90 | 90 |



Tubi LED T8 per collegamento diretto tensione di rete
 o per alimentatore elettromeccanico previa sostituzione starter (starter LED incluso con Tubo LED).
 Non utilizzare in collegamenti in serie.
 Per collegamento diretto alla tensione di rete verificare
 con cura che i pins contrassegnati da "INPUT L-N"
 vengano collegati alla morsettiera in entrata.

T8 LED tubes for direct mains voltage connection
 or for electromagnetic ballast replacing the starter
 (LED starter included with the LED tube).
 Not suitable for series connection.
 For direct connection to mains voltage please
 make sure the pins labeled "INPUT L-N"
 are connected to the terminal board.

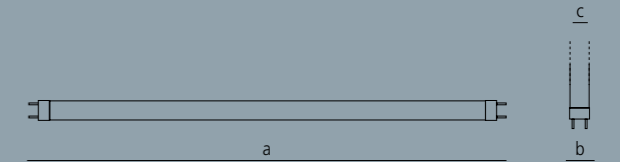
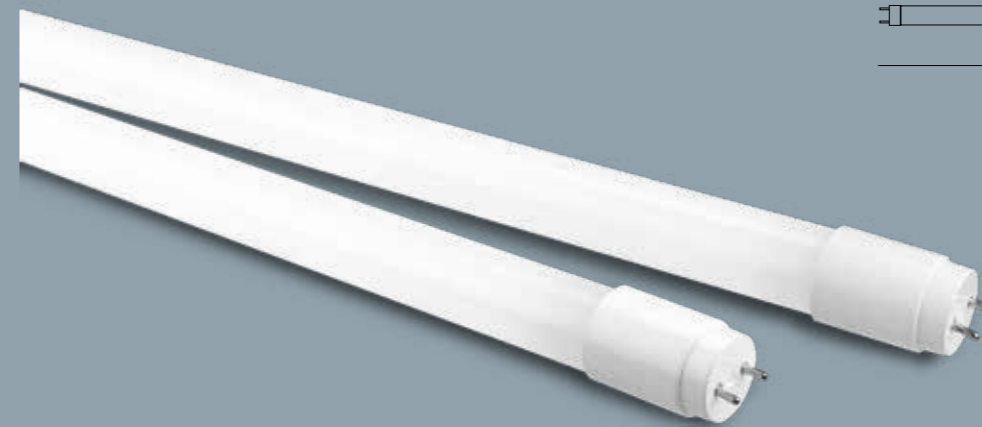

| CODICE / CODE | 21340 | 21341 | 21342 | 21343 | 21344 | 21345 |
|--------------------------------|------------|------------|------------|------------|------------|------------|
| BEAM | 270° | 270° | 270° | 270° | 270° | 270° |
| COLORE LUCE / COLOR T | 4000K | 4000K | 4000K | 6000K | 6000K | 6000K |
| LUMEN | 900 | 1600 | 2400 | 945 | 1680 | 2520 |
| CRI | >80 | >80 | >80 | >80 | >80 | >80 |
| WATT | 9W | 18W | 25W | 9W | 18W | 25W |
| PF | >0,9 | >0,9 | >0,9 | >0,9 | >0,9 | >0,9 |
| SUPPLY | AC175-250V | AC175-250V | AC175-250V | AC175-250V | AC175-250V | AC175-250V |
| KG | 0,18 | 0,26 | 0,38 | 0,18 | 0,26 | 0,38 |
| DIMENSIONI / DIMENSIONS | | | | | | |
| a | 600 | 1200 | 1500 | 600 | 1200 | 1500 |
| b | 28,7 | 28,7 | 28,7 | 28,7 | 28,7 | 28,7 |
| c | 26 | 26 | 26 | 26 | 26 | 26 |

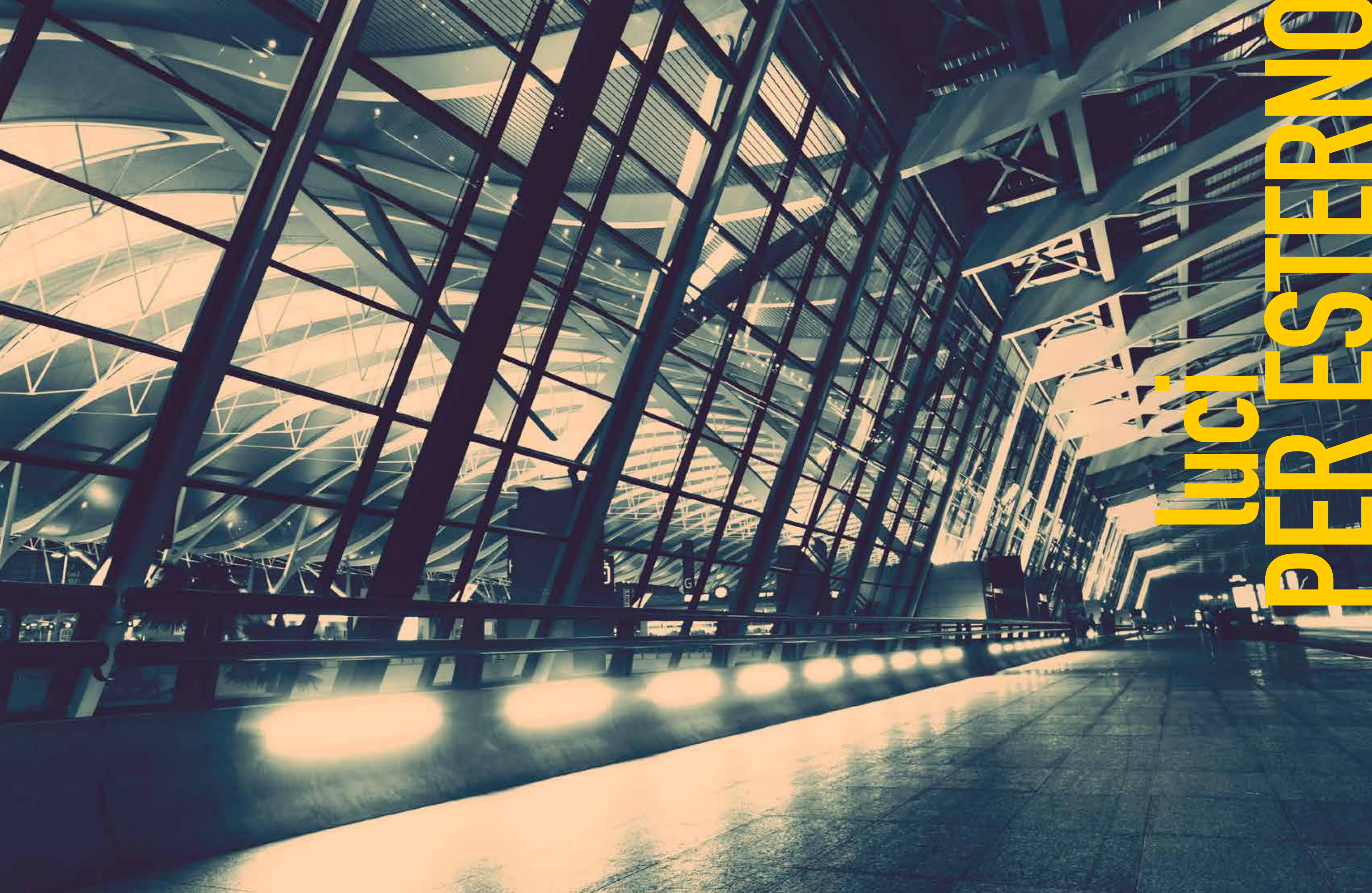

**LUCCI
PER
STERNO**



pag. 89

Proiettore LED integrato
 Corpo in PA6+GF anticorrosione marina
 (10/20/30/50/70/100W)
 Corpo in alluminio pressofuso verniciato (150/200W)
 Schermo in PC
 Classe II (10/20/30/50/70/100W)
 Classe I (150/200W)
 Driver incluso

Floodlight with built-in LED
 Body in PA6+GF marine corrosion
 resistant (10/20/30/50/70/100W)
 Painted die-cast aluminium body (150/200W)
 PC diffuser
 Classe II (10/20/30/50/70/100W)
 Classe I (150/200W)
 Built-in driver

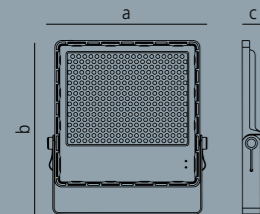

Poseidon



| CODICE / CODE | 40829 | 40830 | 40831 | 40832 | 40833 | 40834 | 40835 | 40836 |
|--------------------------------|------------------|------------------|------------------|------------------|------------------|------------------|------------------|------------------|
| BEAM | 90° | 90° | 90° | 90° | 90° | 90° | 90° | 90° |
| COLORE / COLOUR | nero/black | nero/black | nero/black | nero/black | nero/black | nero/black | nero/black | nero/black |
| COLORE LUCE / COLOR T | 3000K | 3000K | 3000K | 3000K | 3000K | 3000K | 3000K | 3000K |
| LUMEN | 850 | 1700 | 2550 | 4250 | 5950 | 8500 | 12750 | 17000 |
| CRI | >80 | >80 | >80 | >80 | >80 | >80 | >80 | >80 |
| LED | SMD 2835 | SMD 2835 | SMD 2835 | SMD 2835 | SMD 2835 | SMD 2835 | SMD 2835 | SMD 2835 |
| WATT | 10W | 20W | 30W | 50W | 70W | 100W | 150W | 200W |
| PF | >0.5 | >0.5 | >0.9 | >0.9 | >0.9 | >0.9 | >0.9 | >0.9 |
| SUPPLY | 220-240V 50/60Hz | 220-240V 50/60Hz | 220-240V 50/60Hz | 220-240V 50/60Hz | 220-240V 50/60Hz | 220-240V 50/60Hz | 220-240V 50/60Hz | 220-240V 50/60Hz |
| KG | 0,23 | 0,35 | 0,49 | 0,94 | 1,5 | 2,4 | 4,1 | 5,13 |
| PCS | 40 | 32 | 24 | 18 | 8 | 6 | 4 | 4 |
| DIMENSIONI / DIMENSIONS | | | | | | | | |
| a | 137 | 162 | 188 | 256 | 294 | 355 | 332 | 364 |
| b | 140 | 176 | 195 | 250 | 308 | 385 | 352 | 383 |
| c | 33 | 38 | 40 | 45 | 45 | 47 | 60 | 61 |

| CODICE / CODE | 40837 | 40838 | 40839 | 40840 | 40841 | 40842 | 40843 | 40844 |
|--------------------------------|------------------|------------------|------------------|------------------|------------------|------------------|------------------|------------------|
| BEAM | 90° | 90° | 90° | 90° | 90° | 90° | 90° | 90° |
| COLORE / COLOUR | nero/black | nero/black | nero/black | nero/black | nero/black | nero/black | nero/black | nero/black |
| COLORE LUCE / COLOR T | 4000K | 4000K | 4000K | 4000K | 4000K | 4000K | 4000K | 4000K |
| LUMEN | 900 | 1800 | 2700 | 4500 | 6300 | 9000 | 13500 | 18000 |
| CRI | >80 | >80 | >80 | >80 | >80 | >80 | >80 | >80 |
| LED | SMD 2835 | SMD 2835 | SMD 2835 | SMD 2835 | SMD 2835 | SMD 2835 | SMD 2835 | SMD 2835 |
| WATT | 10W | 20W | 30W | 50W | 70W | 100W | 150W | 200W |
| PF | >0.5 | >0.5 | >0.9 | >0.9 | >0.9 | >0.9 | >0.9 | >0.9 |
| SUPPLY | 220-240V 50/60Hz | 220-240V 50/60Hz | 220-240V 50/60Hz | 220-240V 50/60Hz | 220-240V 50/60Hz | 220-240V 50/60Hz | 220-240V 50/60Hz | 220-240V 50/60Hz |
| KG | 0,23 | 0,35 | 0,49 | 0,94 | 1,5 | 2,4 | 4,1 | 5,13 |
| PCS | 40 | 32 | 24 | 18 | 8 | 6 | 4 | 4 |
| DIMENSIONI / DIMENSIONS | | | | | | | | |
| a | 137 | 162 | 188 | 256 | 294 | 355 | 332 | 364 |
| b | 140 | 176 | 195 | 250 | 308 | 385 | 352 | 383 |
| c | 33 | 38 | 40 | 45 | 45 | 47 | 60 | 61 |



Proiettore LED integrato nero
Corpo in pressofusione di alluminio
Diffusore in vetro trasparente e driver integrato

Black LED Floodlight
Die-cast aluminium body
Transparent glass diffuser
Built-in driver



pag. 86-87

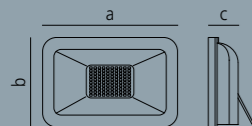
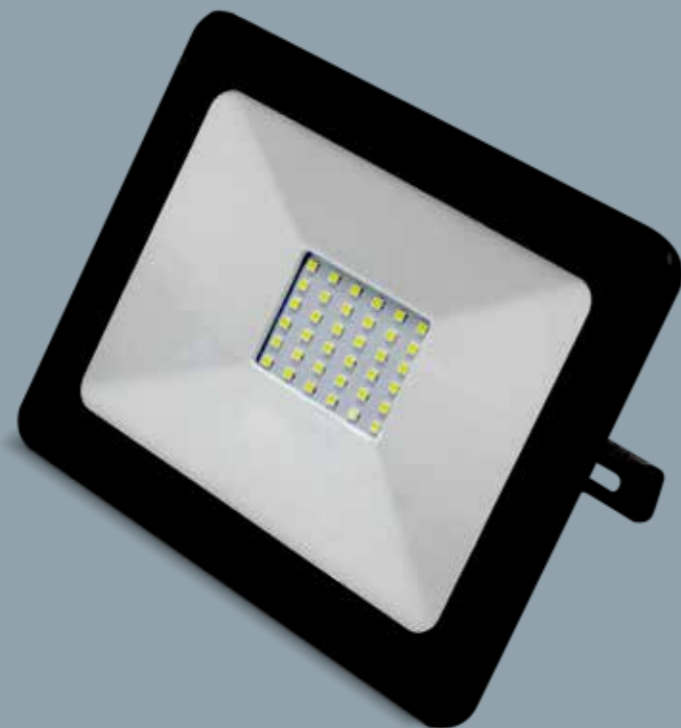

Lampo

| CODICE / CODE | 40552 | 40553 | 40554 | 40555 | 40568 |
|--------------------------------|------------------|------------------|------------------|------------------|------------------|
| BEAM | 120° | 120° | 120° | 120° | 120° |
| COLORE / COLOUR | nero/black | nero/black | nero/black | nero/black | nero/black |
| COLORE LUCE / COLOR T | 3000K | 3000K | 3000K | 3000K | 3000K |
| LUMEN | 802 | 1605 | 2410 | 4050 | 7203 |
| CRI | >80 | >80 | >80 | >80 | >80 |
| WATT | 10W | 20W | 30W | 50W | 100W |
| PF | > 0,9 | > 0,9 | > 0,9 | > 0,9 | > 0,9 |
| SUPPLY | 220/240V 50/60Hz | 220/240V 50/60Hz | 220/240V 50/60Hz | 220/240V 50/60Hz | 220/240V 50/60Hz |
| KG | 0,214 | 0,374 | 0,564 | 0,755 | 0,755 |
| PCS | 40 | 40 | 20 | 20 | 10 |
| DIMENSIONI / DIMENSIONS | | | | | |
| a | 115 | 147 | 190 | 220 | 300 |
| b | 80 | 103 | 132 | 155 | 200 |
| c | 16 | 18 | 18 | 19 | 20 |

| CODICE / CODE | 40556 | 40557 | 40558 | 40559 | 40569 |
|--------------------------------|------------------|------------------|------------------|------------------|------------------|
| BEAM | 120° | 120° | 120° | 120° | 120° |
| COLORE / COLOUR | nero/black | nero/black | nero/black | nero/black | nero/black |
| COLORE LUCE / COLOR T | 4000K | 4000K | 4000K | 4000K | 4000K |
| LUMEN | 830 | 1700 | 2500 | 4130 | 7380 |
| CRI | >80 | >80 | >80 | >80 | >80 |
| WATT | 10W | 20W | 30W | 50W | 100W |
| PF | > 0,9 | > 0,9 | > 0,9 | > 0,9 | > 0,9 |
| SUPPLY | 220/240V 50/60Hz | 220/240V 50/60Hz | 220/240V 50/60Hz | 220/240V 50/60Hz | 220/240V 50/60Hz |
| KG | 0,214 | 0,374 | 0,564 | 0,755 | 0,755 |
| PCS | 40 | 40 | 20 | 20 | 10 |
| DIMENSIONI / DIMENSIONS | | | | | |
| a | 115 | 147 | 190 | 220 | 300 |
| b | 80 | 103 | 132 | 155 | 200 |
| c | 16 | 18 | 18 | 19 | 20 |

| CODICE / CODE | 40560 | 40561 | 40562 | 40563 | 40570 |
|--------------------------------|------------------|------------------|------------------|------------------|------------------|
| BEAM | 120° | 120° | 120° | 120° | 120° |
| COLORE / COLOUR | nero/black | nero/black | nero/black | nero/black | nero/black |
| COLORE LUCE / COLOR T | 6000K | 6000K | 6000K | 6000K | 6000K |
| LUMEN | 850 | 1720 | 2700 | 4500 | 7470 |
| CRI | >80 | >80 | >80 | >80 | >80 |
| WATT | 10W | 20W | 30W | 50W | 100W |
| PF | > 0,9 | > 0,9 | > 0,9 | > 0,9 | > 0,9 |
| SUPPLY | 220/240V 50/60Hz | 220/240V 50/60Hz | 220/240V 50/60Hz | 220/240V 50/60Hz | 220/240V 50/60Hz |
| KG | 0,214 | 0,374 | 0,564 | 0,755 | 0,755 |
| PCS | 40 | 40 | 20 | 20 | 10 |
| DIMENSIONI / DIMENSIONS | | | | | |
| a | 115 | 147 | 190 | 220 | 300 |
| b | 80 | 103 | 132 | 155 | 200 |
| c | 16 | 18 | 18 | 19 | 20 |



Proiettore LED integrato nero
Corpo in pressofusione di alluminio
Diffusore in PC e driver integrato

FOLGORE con sensore
Distanza di rilevamento: entro 12m
Angolo di rilevamento: ca. 90°
Livello di illuminamento: 10 lux
Tempo di accensione: 50± 20s

Black LED Floodlight
Die-cast aluminium body
PC diffuser
Built-in driver

FOLGORE with sensor
Detection distance: within 12m
Detection angle: approx. 90°
Lux level: 10 lux
Delay time: 50± 20s

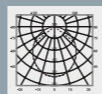

pag. 92-93

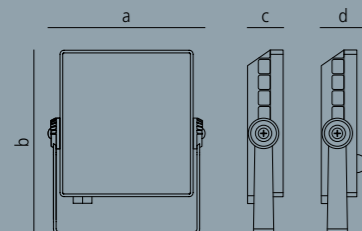

| CODICE / CODE | 40540 | 40541 | 40542 | 40543 | 40544 | 40545 | 40546 | 40547 |
|-------------------------|------------------|------------------|------------------|------------------|------------------|------------------|------------------|------------------|
| BEAM | 110° | 110° | 110° | 110° | 110° | 110° | 110° | 110° |
| COLORE / COLOUR | nero/black | nero/black | nero/black | nero/black | nero/black | nero/black | nero/black | nero/black |
| COLORE LUCE / COLOR T | 3000K | 3000K | 3000K | 3000K | 4000K | 4000K | 4000K | 4000K |
| LUMEN | 780 | 1570 | 2360 | 3950 | 800 | 1600 | 2400 | 4000 |
| CRI | >80 | >80 | >80 | >80 | >80 | >80 | >80 | >80 |
| WATT | 10W | 20W | 30W | 50W | 10W | 20W | 30W | 50W |
| PF | 0,5 | 0,9 | 0,9 | 0,9 | 0,5 | 0,9 | 0,9 | 0,9 |
| SUPPLY | 220-240V 50/60Hz | 220-240V 50/60Hz | 220-240V 50/60Hz | 220-240V 50/60Hz | 220-240V 50/60Hz | 220-240V 50/60Hz | 220-240V 50/60Hz | 220-240V 50/60Hz |
| KG | 0,248 | 0,340 | 0,638 | 1,008 | 0,248 | 0,340 | 0,638 | 1,008 |
| PCS | 12 | 12 | 12 | 6 | 12 | 12 | 12 | 6 |
| DIMENSIONI / DIMENSIONS | | | | | | | | |
| a | 117 | 138 | 167 | 222 | 117 | 138 | 167 | 222 |
| b | 138 | 159 | 220 | 301 | 138 | 159 | 220 | 301 |
| c | 27 | 28 | 36 | 38 | 27 | 28 | 36 | 38 |
| d | - | - | - | - | - | - | - | - |

| CODICE / CODE | 40564 | 40565 | 40566 | 40567 | 40548 SENSOR | 40549 SENSOR | 40550 SENSOR | 40551 SENSOR |
|-------------------------|------------------|------------------|------------------|------------------|------------------|------------------|------------------|------------------|
| BEAM | 110° | 110° | 110° | 110° | 110° | 110° | 110° | 110° |
| COLORE / COLOUR | nero/black | nero/black | nero/black | nero/black | nero/black | nero/black | nero/black | nero/black |
| COLORE LUCE / COLOR T | 6000K | 6000K | 6000K | 6000K | 3000K | 3000K | 3000K | 3000K |
| LUMEN | 808 | 1616 | 2424 | 4040 | 780 | 1570 | 2360 | 3950 |
| CRI | >80 | >80 | >80 | >80 | >80 | >80 | >80 | >80 |
| WATT | 10W | 20W | 30W | 50W | 10W | 20W | 30W | 50W |
| PF | 0,5 | 0,9 | 0,9 | 0,9 | 0,5 | 0,9 | 0,9 | 0,9 |
| SUPPLY | 220-240V 50/60Hz | 220-240V 50/60Hz | 220-240V 50/60Hz | 220-240V 50/60Hz | 220-240V 50/60Hz | 220-240V 50/60Hz | 220-240V 50/60Hz | 220-240V 50/60Hz |
| KG | 0,248 | 0,340 | 0,638 | 1,008 | 0,268 | 0,356 | 0,650 | 1,052 |
| PCS | 12 | 12 | 12 | 6 | 12 | 12 | 12 | 6 |
| DIMENSIONI / DIMENSIONS | | | | | | | | |
| a | 117 | 138 | 167 | 222 | 117 | 138 | 167 | 222 |
| b | 138 | 159 | 220 | 301 | 138 | 159 | 220 | 301 |
| c | 27 | 28 | 36 | 38 | 27 | 28 | 36 | 38 |
| d | - | - | - | - | 41 | 42 | 50 | 52 |

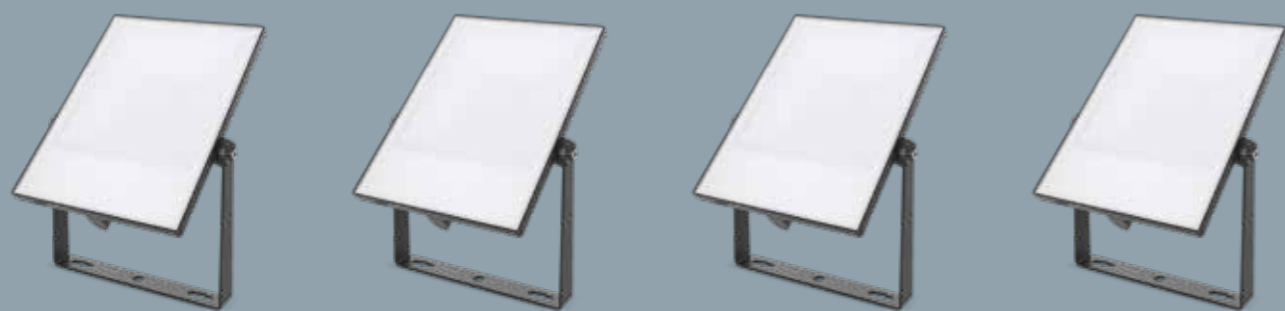

Folgore



Apparecchio a soffitto LED integrato
con sensore di presenza
Corpo in termoplastico
Diffusore in PC opale

Built-in LED downlight with integrated
PIR sensor
Thermoplastic body
Opal PC diffuser

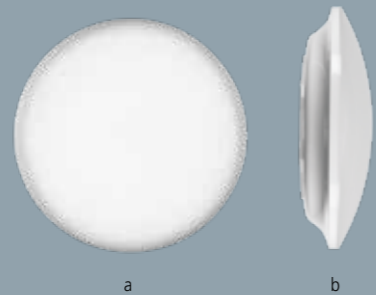

Sensore di presenza 5/6 mt
Microwave sensor 5/6 mt

| CODICE / CODE | 42576 | 42577 | 42578 |
|-------------------------|--------------|--------------|--------------|
| COLORE / COLOUR | bianco/white | bianco/white | bianco/white |
| COLORE LUCE / COLOR T | 3000K | 4000K | 6000K |
| LUMEN | 2850 | 3000 | 3150 |
| CRI | 80 | 80 | 80 |
| LED | Sanan | Sanan | Sanan |
| WATT | 30W | 30W | 30W |
| PF | 0,9 | 0,9 | 0,9 |
| SUPPLY | 230V 50/60Hz | 230V 50/60Hz | 230V 50/60Hz |
| KG | 0,152 | 0,152 | 0,152 |
| PCS | 20 | 20 | 20 |
| DIMENSIONI / DIMENSIONS | | | |
| a | 350 | 350 | 350 |
| b | 102 | 102 | 102 |





Apparecchio LED integrato
Corpo in TRP
Schermo in PC opale
Driver integrato

Built-in LED fitting
TRP body
Opal PC screen
Built-in driver

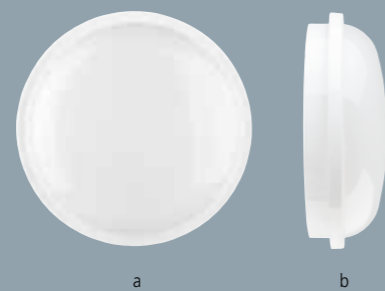

| CODICE / CODE | 40303 | 40304 |
|--------------------------------|--------------|--------------|
| BEAM | 110° | 110° |
| COLORE / COLOUR | bianco/white | bianco/white |
| COLORE LUCE / COLOR T | 4000K | 4000K |
| LUMEN | 1250 | 1650 |
| CRI | >80 | >80 |
| LED | Epistar | Epistar |
| WATT | 15W | 20W |
| PF | >0,5 | >0,5 |
| SUPPLY | 230V 50/60Hz | 230V 50/60Hz |
| KG | 0,25 | 0,40 |
| PCS | 20 | 20 |
| DIMENSIONI / DIMENSIONS | | |
| a | 167 | 221 |
| b | 62 | 72 |



Apparecchio LED integrato
Corpo in TRP
Schermo in PC opale
Driver integrato

Built-in LED fitting
TRP body
Opal PC screen
Built-in driver

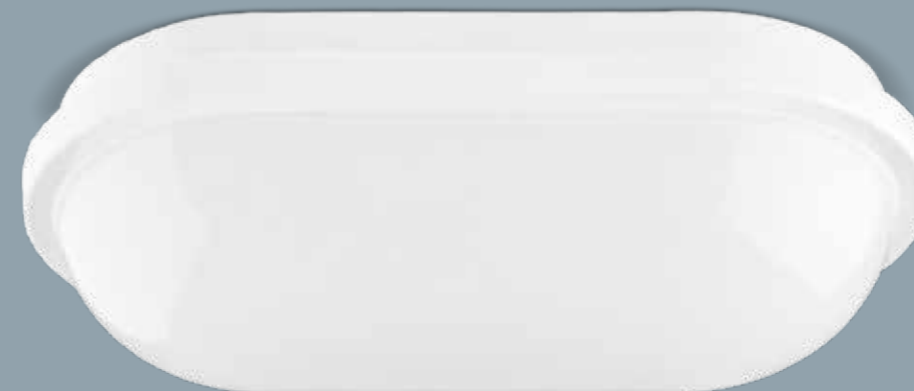

| CODICE / CODE | 40305 | 40306 |
|--------------------------------|--------------|--------------|
| BEAM | 110° | 110° |
| COLORE / COLOUR | bianco/white | bianco/white |
| COLORE LUCE / COLOR T | 4000K | 4000K |
| LUMEN | 1250 | 1650 |
| CRI | >80 | >80 |
| LED | Epistar | Epistar |
| WATT | 15W | 20W |
| PF | >0,5 | >0,5 |
| SUPPLY | 230V 50/60Hz | 230V 50/60Hz |
| KG | 0,29 | 0,42 |
| PCS | 20 | 20 |
| DIMENSIONI / DIMENSIONS | | |
| a | 215 | 271 |
| b | 115 | 146 |
| c | 62 | 76 |



Apparecchio a soffitto LED integrato
Corpo in alluminio verniciato
Schermo in PC opale
Driver integrato

Ceiling fitting with built-in LED
Painted aluminium body
Opal PC screen
Built-in driver

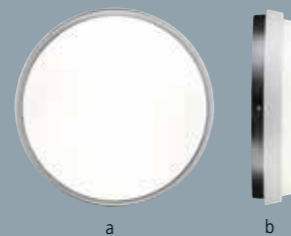

| CODICE / CODE | 40232 | 40234 |
|-------------------------|--------------|--------------|
| COLORE / COLOUR | bianco/white | bianco/white |
| COLORE LUCE / COLOR T | 3000K | 5000K |
| LUMEN | 2000 | 2100 |
| CRI | >80 | >80 |
| LED | SMD Edison | SMD Edison |
| WATT | 26W | 26W |
| PF | 0,95 | 0,95 |
| SUPPLY | 230V 50/60Hz | 230V 50/60Hz |
| KG | 0,81 | 0,81 |
| PCS | 8 | 8 |
| DIMENSIONI / DIMENSIONS | | |
| a | 240 | 240 |
| b | 45 | 45 |

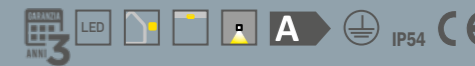

Apparecchio a soffitto LED integrato
Corpo in alluminio verniciato
Schermo in PC opale
Driver integrato

Ceiling fitting with built-in LED
Painted aluminium body
Opal PC screen
Built-in driver

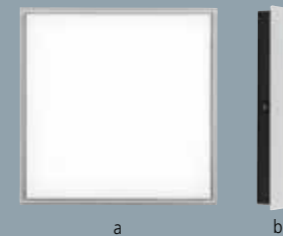
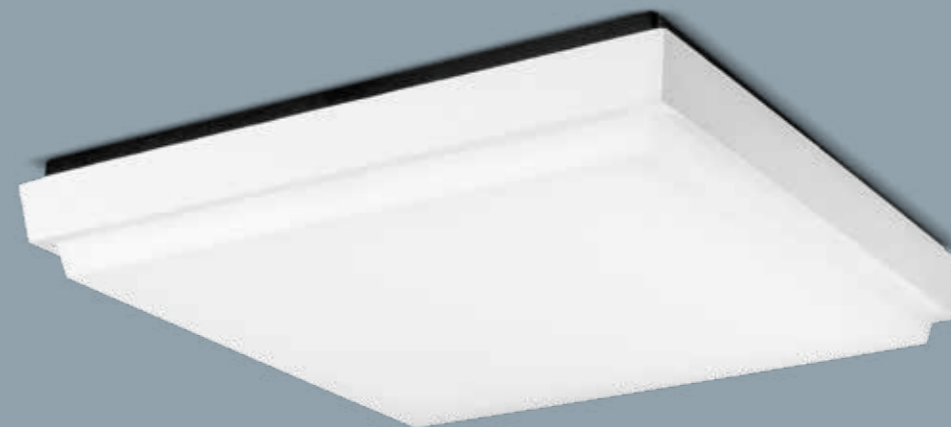

| CODICE / CODE | 40243 | 40245 |
|-------------------------|--------------|--------------|
| COLORE / COLOUR | bianco/white | bianco/white |
| COLORE LUCE / COLOR T | 3000K | 5000K |
| LUMEN | 2000 | 2100 |
| CRI | >80 | >80 |
| LED | SMD Edison | SMD Edison |
| WATT | 26W | 26W |
| PF | 0,95 | 0,95 |
| SUPPLY | 230V 50/60Hz | 230V 50/60Hz |
| KG | 1 | 1 |
| PCS | 8 | 8 |
| DIMENSIONI / DIMENSIONS | | |
| a | 240 | 240 |
| b | 45 | 45 |

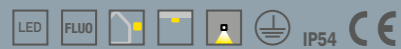

Apparecchio a soffitto
Corpo in pressofusione di alluminio
verniciato
Schermo in PC opale

Recessed fitting with
built-in LED
TRP body
Opal PC diffuser

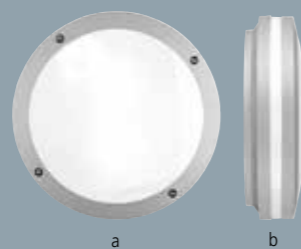

| | |
|--------------------------------|--------------|
| CODICE / CODE | 40323 |
| COLORE / COLOUR | grigio/grey |
| LAMP | E27 |
| WATT | Max 2x20W |
| SUPPLY | 230V 50/60Hz |
| KG | 1,2 |
| PCS | 6 |
| DIMENSIONI / DIMENSIONS | |
| a | 300 |
| b | 86 |



Apparecchio a soffitto
Corpo in pressofusione di alluminio verniciato
Schermo in PC opale

Ceiling fitting
Painted die-cast aluminium body
Opal PC screen

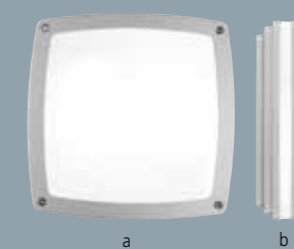
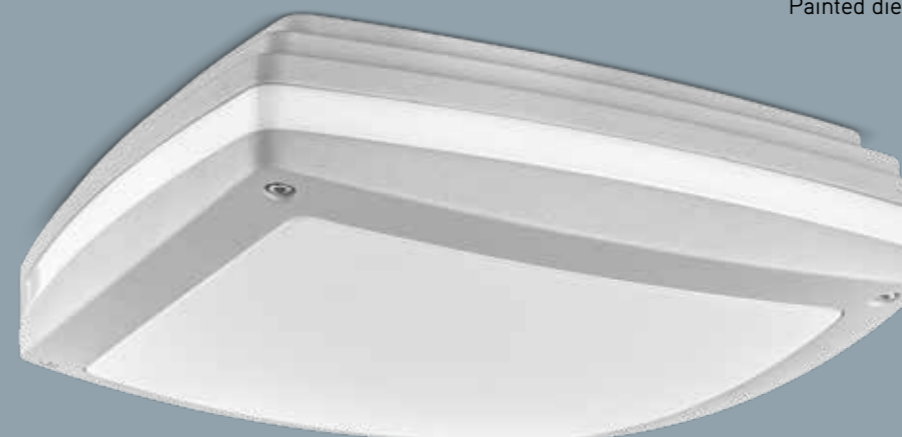

| | |
|--------------------------------|--------------|
| CODICE / CODE | 40324 |
| COLORE / COLOUR | grigio/grey |
| LAMP | E27 |
| WATT | Max 2x20W |
| SUPPLY | 230V 50/60Hz |
| KG | 1,2 |
| PCS | 6 |
| DIMENSIONI / DIMENSIONS | |
| a | 300 |
| b | 86 |



Apparecchio a soffitto
Base in pressofusione di alluminio
Schermo in PC opale

Ceiling fitting
Die-cast aluminium base
Opal PC screen

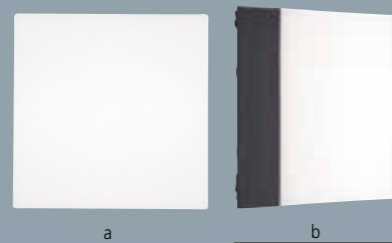
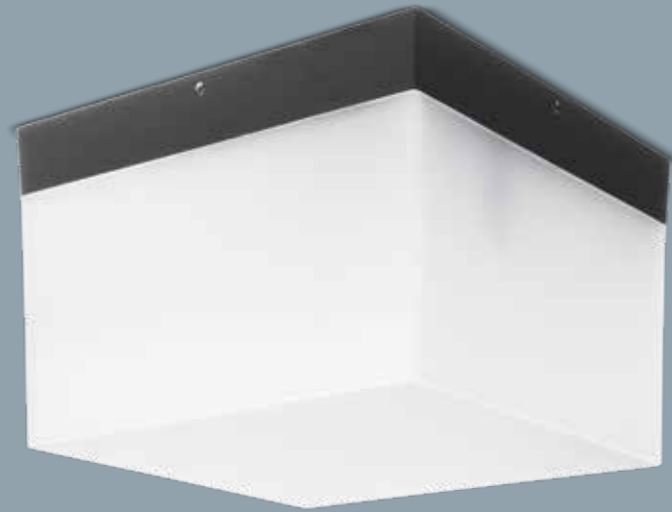

| CODICE / CODE | 40154 | 40155 |
|--------------------------------|--------------|--------------|
| COLORE / COLOUR | nero/black | nero/black |
| LAMP | Gx53-1 | E27 |
| WATT | Max 11W | Max 2x15W |
| SUPPLY | 230V 50/60Hz | 230V 50/60Hz |
| KG | 0,7 | 1,4 |
| PCS | 12 | 6 |
| DIMENSIONI / DIMENSIONS | | |
| a | 142 | 207 |
| b | 111 | 141 |

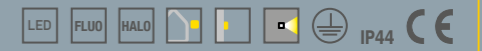

Apparecchio a parete
Corpo in pressofusione di alluminio verniciato
Diffusore in PC opale

Wall fitting
Painted die-cast aluminium body
Opal PC diffuser

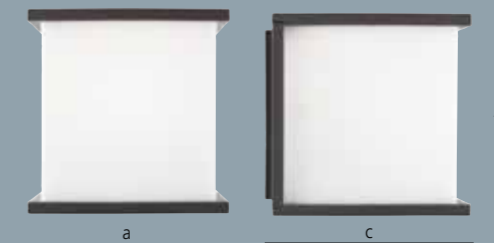

| CODICE / CODE | 40348 |
|--------------------------------|--------------|
| COLORE / COLOUR | nero/black |
| LAMP | E27 |
| WATT | Max 42W |
| SUPPLY | 230V 50/60Hz |
| KG | 1 |
| PCS | 8 |
| DIMENSIONI / DIMENSIONS | |
| a | 165 |
| b | 165 |
| c | 171 |



Apparecchio a parete
Corpo in pressofusione di alluminio verniciato
Diffusore in PC opale

Wall fitting
Painted die-cast aluminium body
Opal PC diffuser

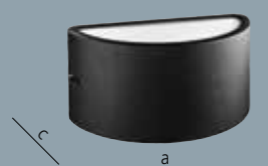
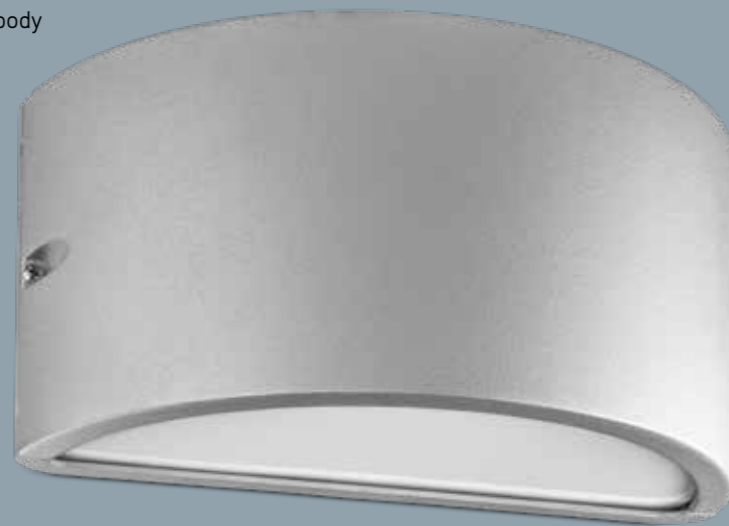

| CODICE / CODE | 42043 | 42034 |
|-------------------------|--------------|--------------|
| COLORE / COLOUR | grigio/grey | nero/black |
| LAMP | E27 | E27 |
| WATT | Max 52W | Max 52W |
| SUPPLY | 230V 50/60Hz | 230V 50/60Hz |
| KG | 0,9 | 0,9 |
| PCS | 12 | 12 |
| DIMENSIONI / DIMENSIONS | | |
| a | 250 | 250 |
| b | 120 | 120 |
| c | 135 | 135 |



Apparecchio a parete
Corpo in pressofusione di alluminio
verniciato
Diffusore in PC opale

Wall fitting
Painted die-cast aluminium body
Opal PC diffuser

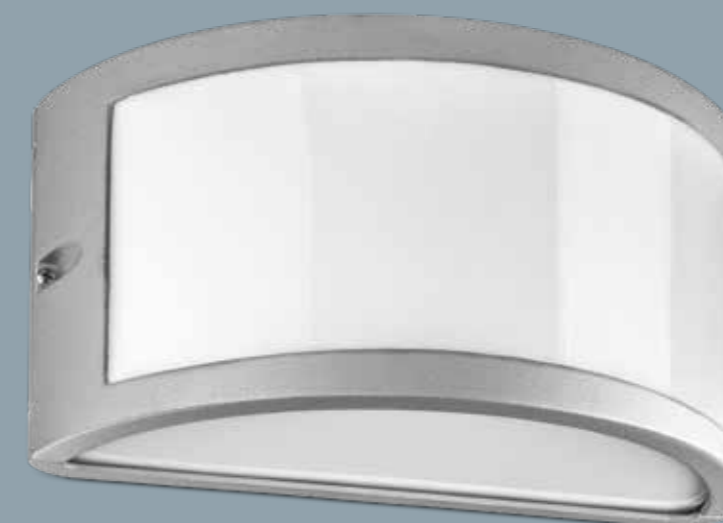

| CODICE / CODE | 40205 | 40206 |
|-------------------------|--------------|--------------|
| COLORE / COLOUR | grigio/grey | nero/black |
| LAMP | E27 | E27 |
| WATT | Max 52W | Max 52W |
| SUPPLY | 230V 50/60Hz | 230V 50/60Hz |
| KG | 0,88 | 0,88 |
| PCS | 12 | 12 |
| DIMENSIONI / DIMENSIONS | | |
| a | 250 | 250 |
| b | 120 | 120 |
| c | 135 | 135 |



Paletto
Corpo in pressofusione di alluminio verniciato
Schermo in vetro satinato

Pole
Painted die-cast aluminium body
Frosted glass screend



| | |
|--------------------------------|-----------------------|
| CODICE / CODE | 40182 |
| COLORE / COLOUR | palo grigio/pole grey |
| LAMP | E27 |
| WATT | Max 18W |
| SUPPLY | 230V 50/60Hz |
| KG | 2,8 |
| PCS | 4 |
| DIMENSIONI / DIMENSIONS | |
| a | 110 |
| b | 650 |



Paletto
Corpo in pressofusione di alluminio verniciato
Diffusore in PC opale

Pole
Painted die-cast aluminium body
Opal PC diffuser

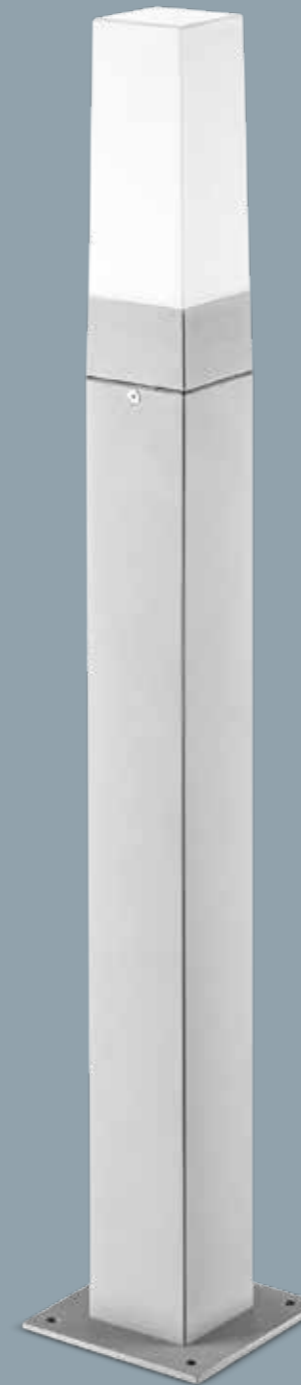

| | |
|--------------------------------|--------------|
| CODICE / CODE | 40322 |
| COLORE / COLOUR | grigio/grey |
| LAMP | E27 |
| WATT | Max 15W |
| SUPPLY | 230V 50/60Hz |
| KG | 1,4 |
| PCS | 6 |
| DIMENSIONI / DIMENSIONS | |
| a | 113 |
| b | 700 |



Segnapasso LED integrato
Corpo in ABS
Cornice in acciaio inox
Schermo in PC trasparente
Cassaforma in PVC
Driver integrato

Wall-step with built-in LED
ABS body
Stainless steel frame
Transparent PC screen
PVC frame-work
Built-in driver

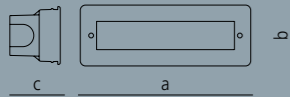

Segnapasso LED integrato
Corpo in ABS
Cornice in acciaio inox
Schermo in PC opale
Cassaforma in PVC
Driver integrato

Wall-step with built-in LED
ABS body
Stainless steel frame
Opal PC screen
PVC frame-work
Built-in driver

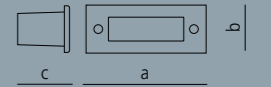

| CODICE / CODE | 45608 | 45609 | 45598 | 45599 |
|--------------------------------|--------------|--------------|--------------|--------------|
| COLORE LUCE / COLOR T | 3000K | 3000K | 5000K | 5000K |
| LUMEN | 65 | 130 | 90 | 195 |
| LED | RE-FOND | RE-FOND | RE-FOND | RE-FOND |
| WATT | 1,5W | 3,2W | 1,5W | 3,2W |
| SUPPLY | 230V 50/60Hz | 230V 50/60Hz | 230V 50/60Hz | 230V 50/60Hz |
| FORO / HOLE | 139x56 | 190x65 | 139x56 | 190x65 |
| KG | 0,3 | 0,83 | 0,3 | 0,83 |
| PCS | 50 | 12 | 50 | 12 |
| DIMENSIONI / DIMENSIONS | | | | |
| a | 146 | 196 | 146 | 196 |
| b | 60 | 70 | 60 | 70 |
| c | 60 | 60 | 60 | 60 |

| CODICE / CODE | 45610 | 45611 | 45601 | 45600 |
|--------------------------------|--------------|--------------|--------------|--------------|
| COLORE LUCE / COLOR T | 3000K | 3000K | 5000K | 5000K |
| LUMEN | 35 | 40 | 46 | 60 |
| LED | RE-FOND | RE-FOND | RE-FOND | RE-FOND |
| WATT | 0,8W | 1W | 0,8W | 1W |
| SUPPLY | 230V 50/60Hz | 230V 50/60Hz | 230V 50/60Hz | 230V 50/60Hz |
| FORO / HOLE | 67x62 | 105x32 | 67x62 | 105x32 |
| KG | 0,17 | 0,2 | 0,17 | 0,2 |
| PCS | 50 | 50 | 50 | 50 |
| DIMENSIONI / DIMENSIONS | | | | |
| a | 70 | 110 | 70 | 110 |
| b | 70 | 44 | 70 | 44 |
| c | 55 | 54 | 55 | 54 |



Incasso calpestabile
 Corpo in pressofusione di alluminio
 Anello in acciaio inox AISI 316
 Vetro temperato trasparente
 Cassaforma in PVC

Walk-over recessed fitting
 Die-cast aluminium body
 AISI 316 stainless steel ring
 Transparent tempered glass
 PVC frame-work



| | |
|--------------------------------|--------------|
| CODICE / CODE | 40157 |
| COLORE / COLOUR | INOX |
| LAMP | GU10 |
| WATT | HALO Max 50W |
| SUPPLY | 230V 50/60Hz |
| FORO / HOLE | ø100 |
| KG | 0,7 |
| PCS | 20 |
| DIMENSIONI / DIMENSIONS | |
| a | 105 |
| b | 100 |
| c | 115 |
| d | 140 |

| | |
|--------------------|--------------------------------------|
| ACCESSORI | 40015 Connettore IP67 una via |
| ACCESSORIES | 40016 Connettore IP67 due via |



Incasso calpestabile
 Corpo in pressofusione di alluminio
 Anello in acciaio inox AISI 316
 Vetro temperato trasparente
 Cassaforma in PVC

Walk-over recessed fitting
 Die-cast aluminium body
 AISI 316 stainless steel ring
 Transparent tempered glass
 PVC frame-work

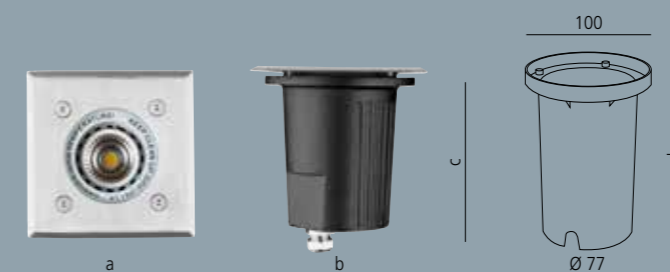

| | |
|--------------------------------|--------------|
| CODICE / CODE | 42535 |
| COLORE / COLOUR | INOX |
| LAMP | GU10 |
| WATT | HALO Max 50W |
| SUPPLY | 230V 50/60Hz |
| FORO / HOLE | ø100 |
| KG | 0,7 |
| PCS | 20 |
| DIMENSIONI / DIMENSIONS | |
| a | 105 |
| b | 100 |
| c | 115 |
| d | 140 |

| | |
|--------------------|--------------------------------------|
| ACCESSORI | 40015 Connettore IP67 una via |
| ACCESSORIES | 40016 Connettore IP67 due via |





Incasso calpestabile LED integrato
 Corpo in alluminio anodizzato
 Cassaforma in PVC
 Driver escluso

Walk-over recessed fitting with built-in LED
 Anodized aluminium body
 PVC framework
 Driver not included

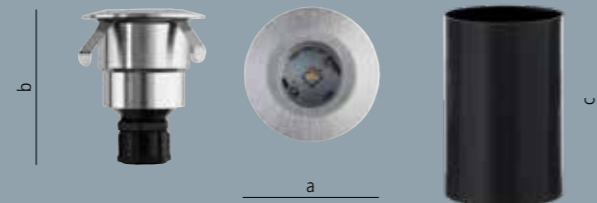

| CODICE / CODE | 42536 | 42541 |
|--------------------------------|-----------|-----------|
| BEAM | 60° | 60° |
| COLORE LUCE / COLOR T | 3000K | 5000K |
| LUMEN | 70 | 90 |
| LED | RE-FOND | RE-FOND |
| WATT | 1W | 1W |
| SUPPLY | 12V DC/AC | 12V DC/AC |
| FORO / HOLE | ø35 | ø35 |
| KG | 0,15 | 0,15 |
| PCS | 50 | 50 |
| DIMENSIONI / DIMENSIONS | | |
| a | 40 | 40 |
| b | 57 | 57 |
| c | 70 | 70 |





Apparecchio a parete
Corpo in metallo verniciato
Diffusore in vetro

Wall fitting
Painted metal body
Glass diffuser



| CODICE / CODE | 41504 | 41505 |
|--------------------------------|--------------|--------------|
| COLORE / COLOUR | Ruggine/Rust | Ruggine/Rust |
| LAMP | E27 | E27 |
| WATT | Max 70W | Max 70W |
| SUPPLY | 230V 50/60Hz | 230V 50/60Hz |
| KG | 0,96 | 1,5 |
| PCS | 4 | 2 |
| DIMENSIONI / DIMENSIONS | | |
| a | 270 | 350 |
| b | 370 | 510 |
| c | 280 | 375 |



Apparecchio a sospensione
Corpo in metallo verniciato
Diffusore in vetro

Suspension fitting
Painted metal body
Glass diffuser



| CODICE / CODE | 41506 | 41507 |
|--------------------------------|--------------|--------------|
| COLORE / COLOUR | Ruggine/Rust | Ruggine/Rust |
| LAMP | E27 | E27 |
| WATT | Max 70W | Max 70W |
| SUPPLY | 230V 50/60Hz | 230V 50/60Hz |
| KG | 1 | 1,35 |
| PCS | 4 | 2 |
| DIMENSIONI / DIMENSIONS | | |
| a | 270 | 350 |
| b | 1030 | 1140 |

Trasformatore elettronico LED 12V

LED electronic transformer 12V



| | |
|-------------------------------|--------------------------------------------------------------------------------|
| CODICE / CODE | 21918 |
| | 220-240V AC / 50Hz Collegare max 3 lampadine LED Connect max 3 LED bulbs |
| PRIMARIO / MAINS | |
| SECONDARIO / SECONDARY | 12V |
| W | 2-30W |
| IP | 20 |
| DIMENSIONS | 80 x 38 x H28 |



| | |
|-------------------------------|------------------------------------------------------------------------------------|
| CODICE / CODE | 22918 |
| | 220-240V AC / 50Hz Collegare max 4/5 lampadine LED Connect max 4/5 LED bulbs |
| PRIMARIO / MAINS | |
| SECONDARIO / SECONDARY | 12V |
| W | 2-50W |
| IP | 20 |
| DIMENSIONS | 117 x 32 x H20 |

dati tecnici
FOTOMETRIE

3000K 10W 3000K 15W 3000K 25W 3000K 30W

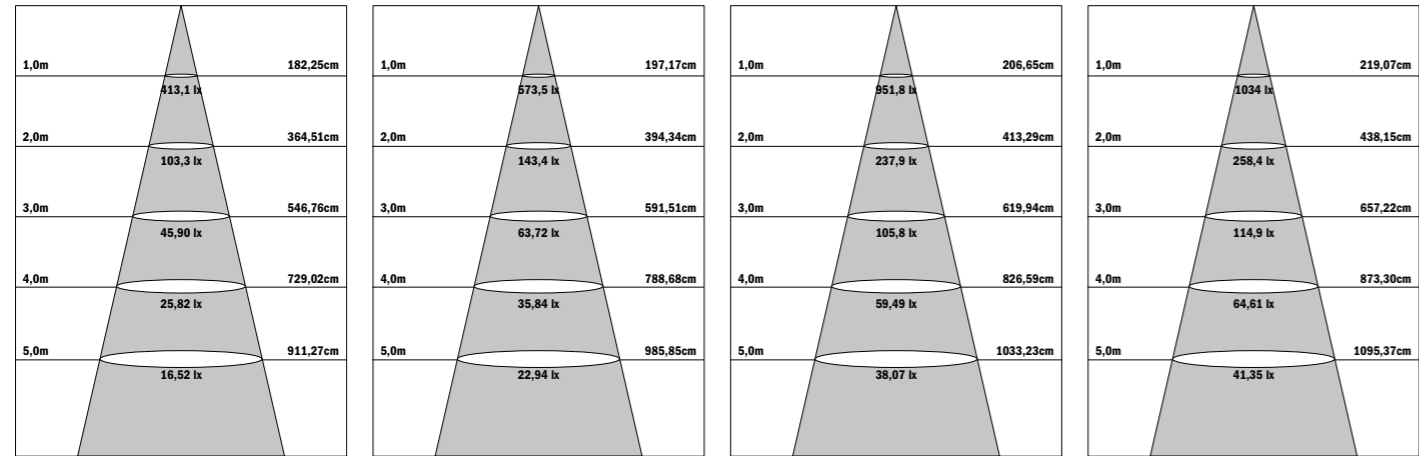
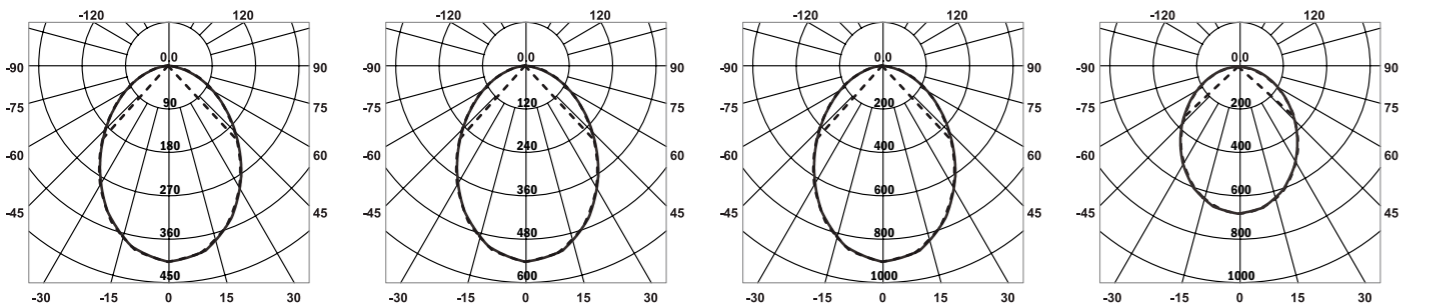

4000°K 120W 60° 6000°K 120W 60° 4000°K 120W 90° 6000°K 120W 90°

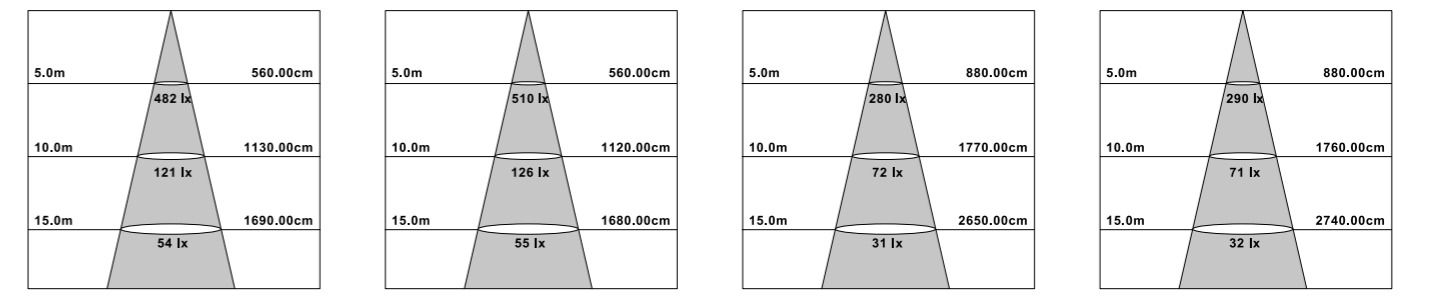
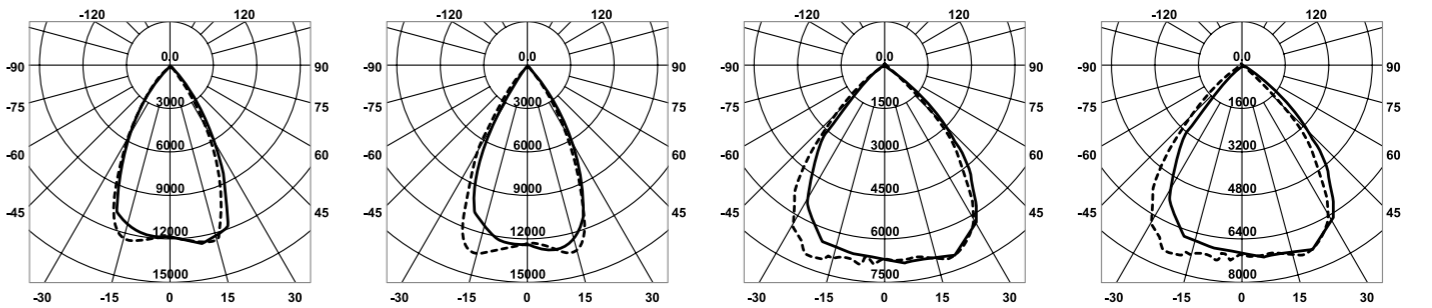

4000K 10W 4000K 15W 4000K 25W 4000K 30W

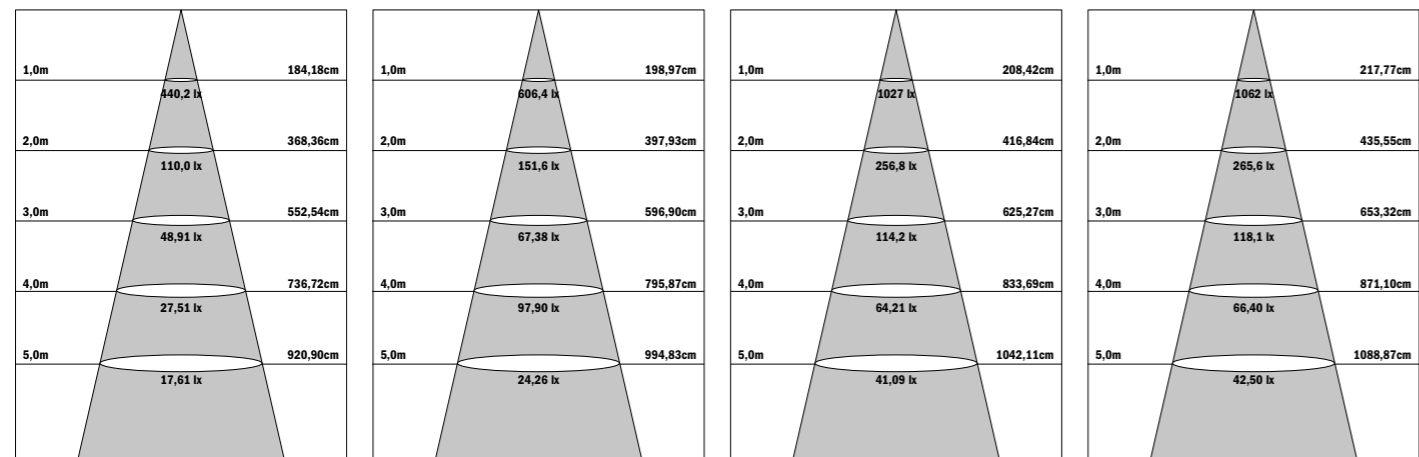
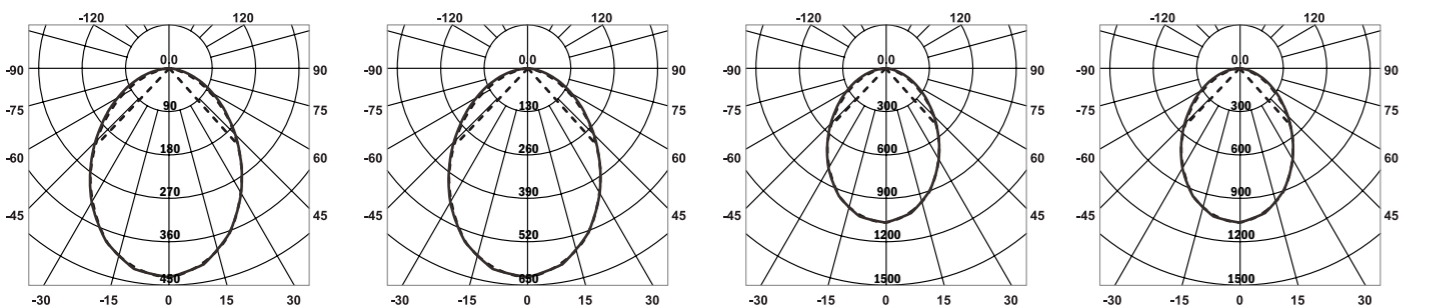

4000°K 150W 60° 6000°K 150W 60° 4000°K 150W 90° 6000°K 150W 90°

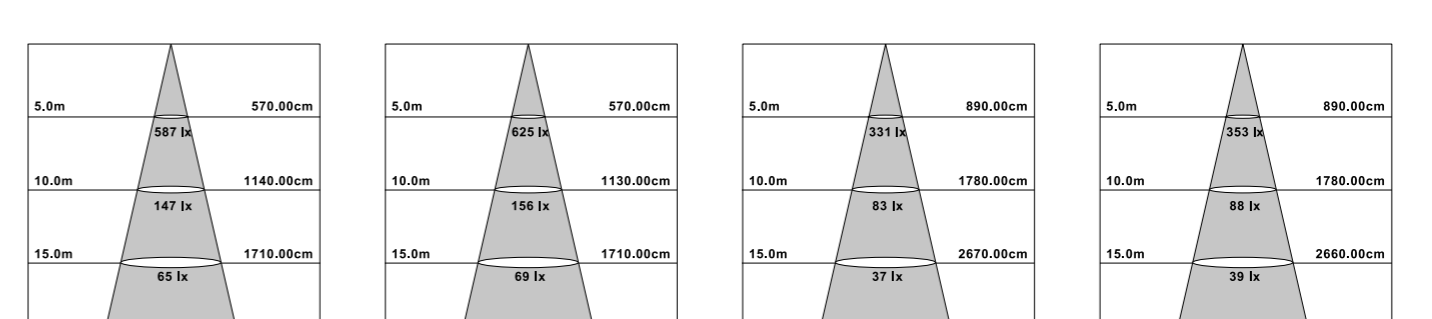
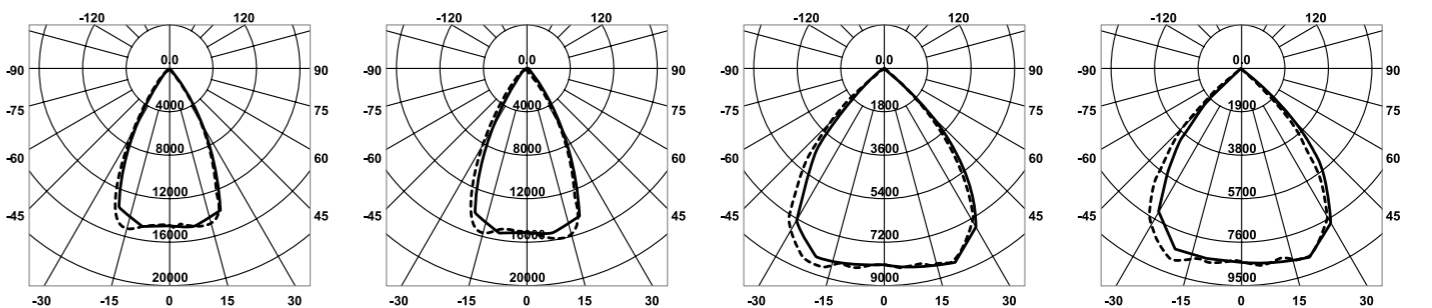

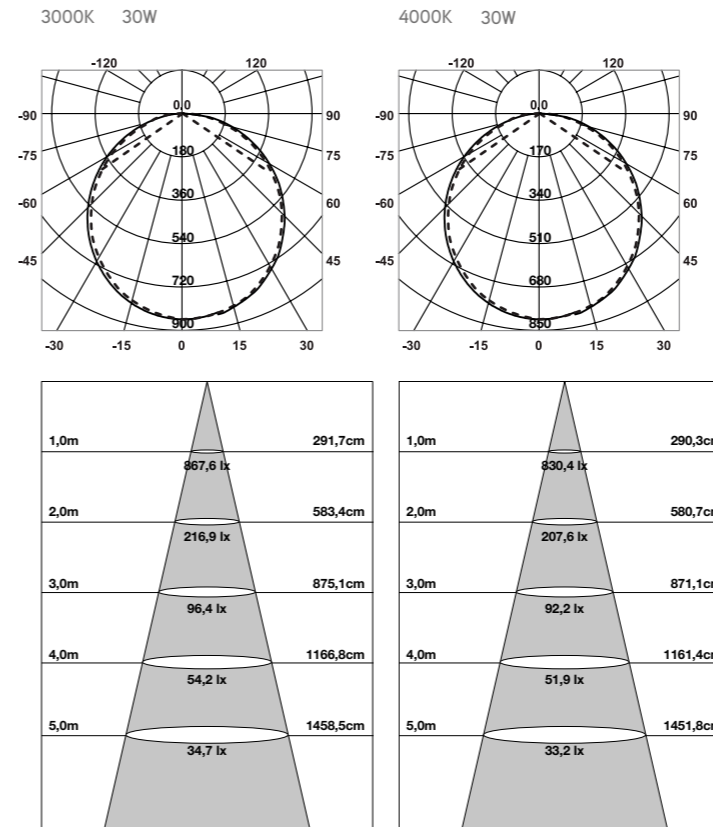
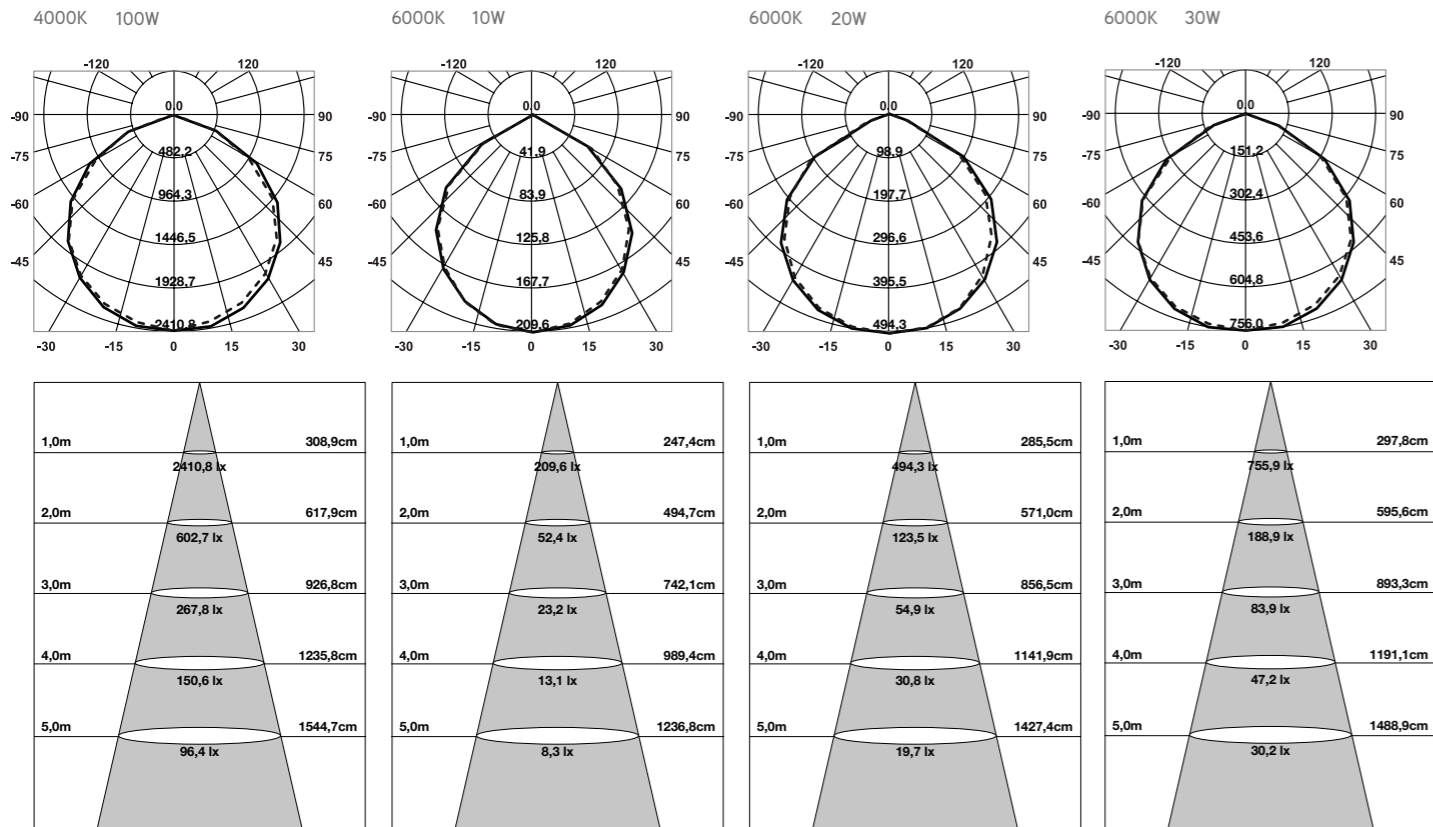
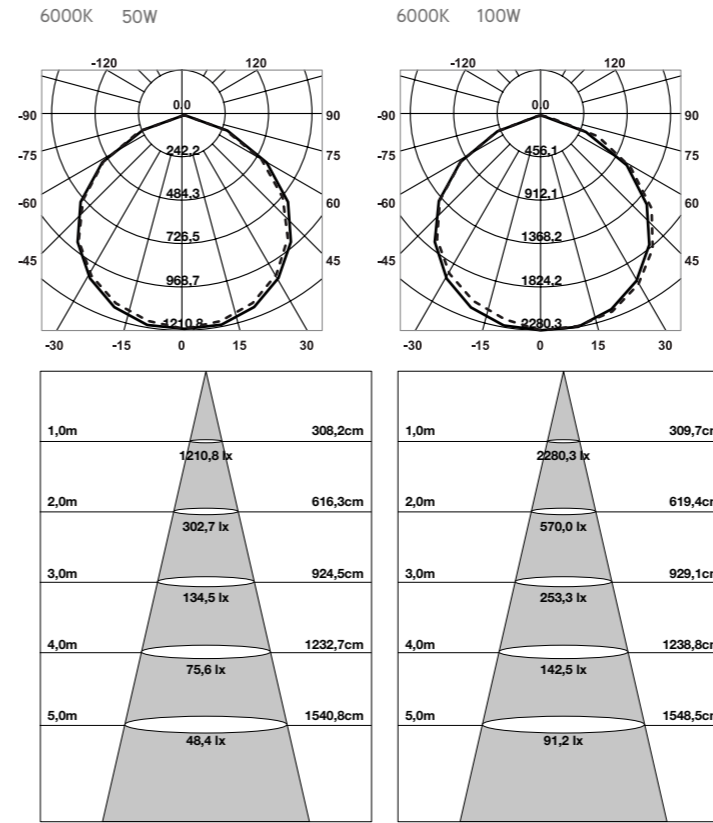
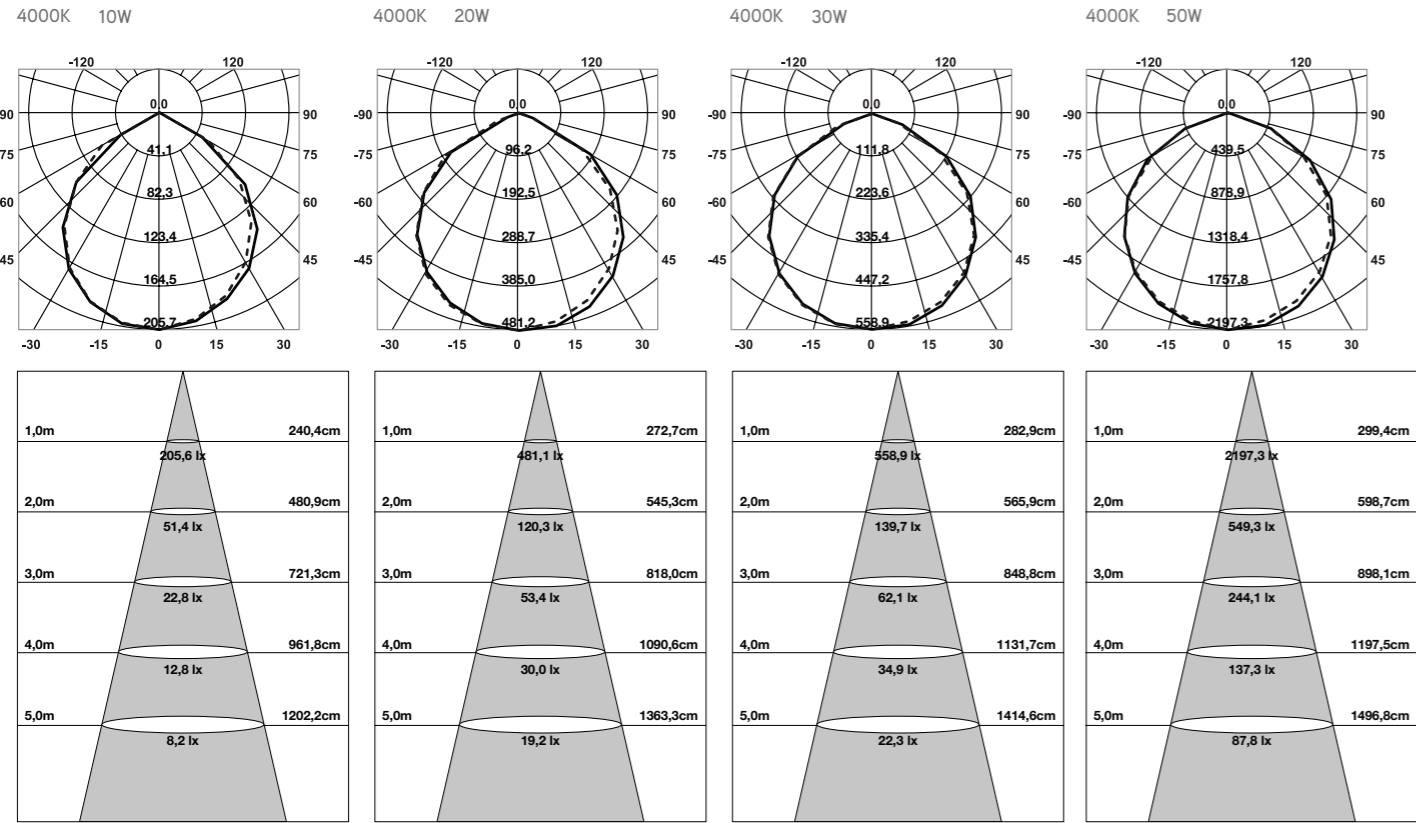

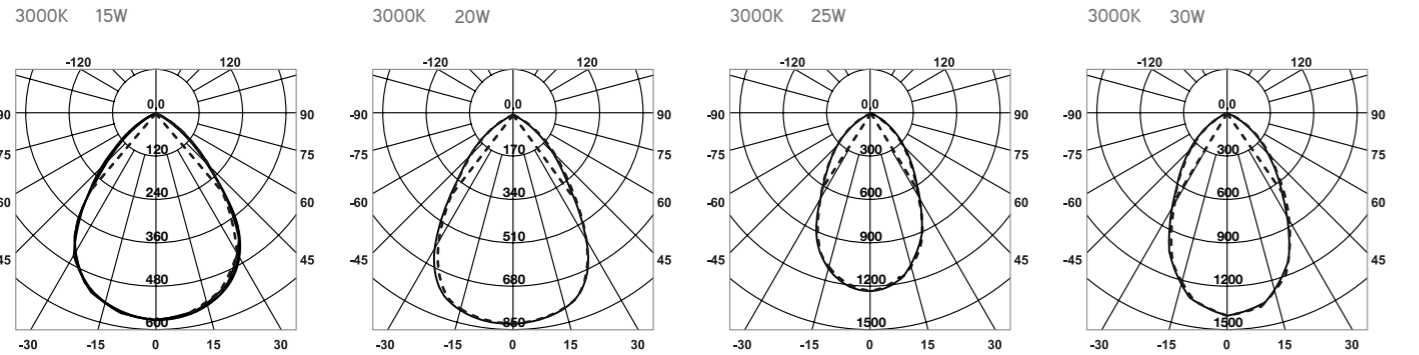

| | | | | | |
|------|---------|----------|----------|---------|---------|
| 1,0m | 169,3cm | 589 lx | 830 lx | 1247 lx | 1421 lx |
| 2,0m | 338,6cm | 147,3 lx | 207,6 lx | 251,5cm | 253,4cm |
| 3,0m | 507,9cm | 65,4 lx | 92,2 lx | 377,3cm | 380,2cm |
| 4,0m | 677,3cm | 36,8 lx | 51,9 lx | 503,1cm | 506,9cm |
| 5,0m | 846,6cm | 23,5 lx | 33,2 lx | 628,9cm | 633,7cm |

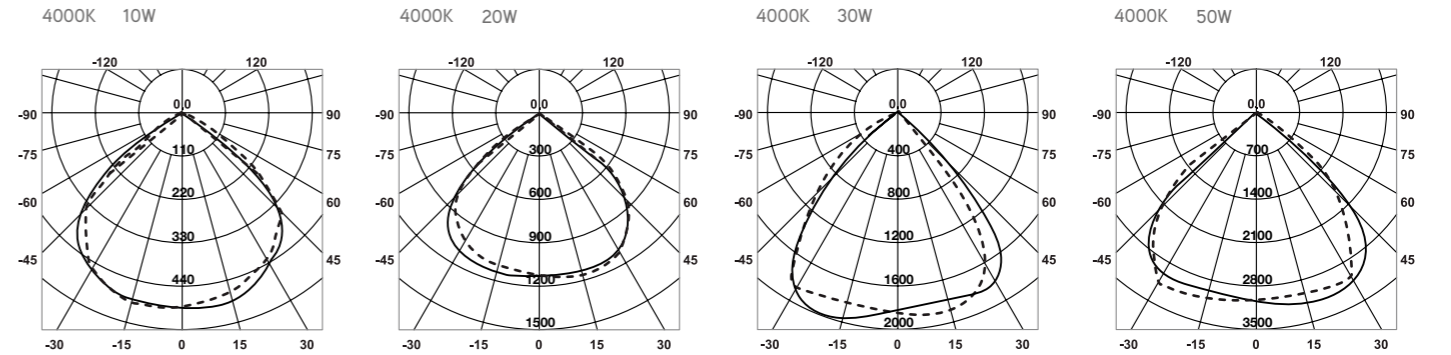

| | | | | | |
|-------|--------|--------|--------|--------|--------|
| 2,0m | 470cm | 127 lx | 276 lx | 474 lx | 751 lx |
| 4,0m | 930cm | 32 lx | 69 lx | 119 lx | 188 lx |
| 6,0m | 1400cm | 14 lx | 31 lx | 53 lx | 83 lx |
| 8,0m | 1870cm | 8 lx | 17 lx | 30 lx | 47 lx |
| 10,0m | 2330cm | 5 lx | 11 lx | 19 lx | 30 lx |

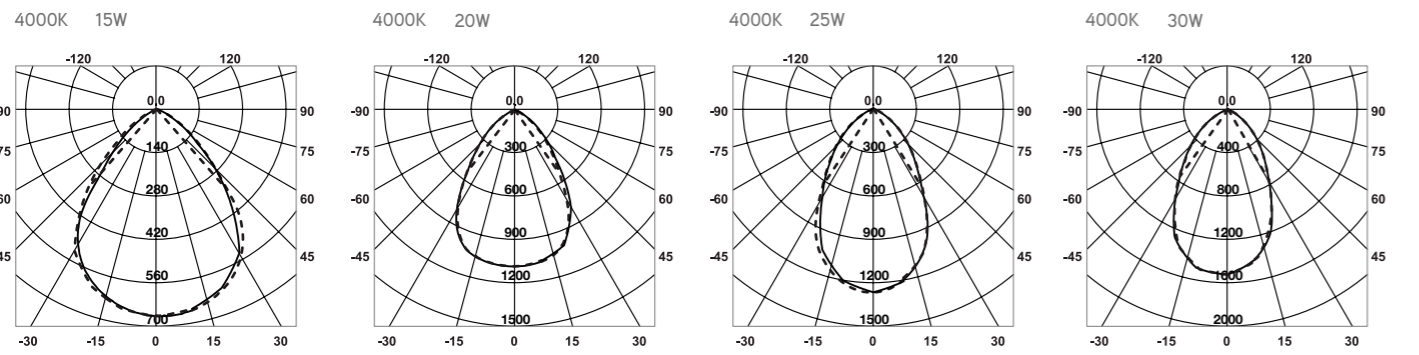

| | | | | | |
|------|---------|----------|----------|---------|---------|
| 1,0m | 169,1cm | 679 lx | 1099 lx | 1291 lx | 1546 lx |
| 2,0m | 338,3cm | 169,9 lx | 274,8 lx | 255,1cm | 251,3cm |
| 3,0m | 507,5cm | 75,5 lx | 122,2 lx | 382,6cm | 377,0cm |
| 4,0m | 677,7cm | 42,4 lx | 68,7 lx | 510,2cm | 502,6cm |
| 5,0m | 845,8cm | 27,1 lx | 43,9 lx | 637,7cm | 628,3cm |

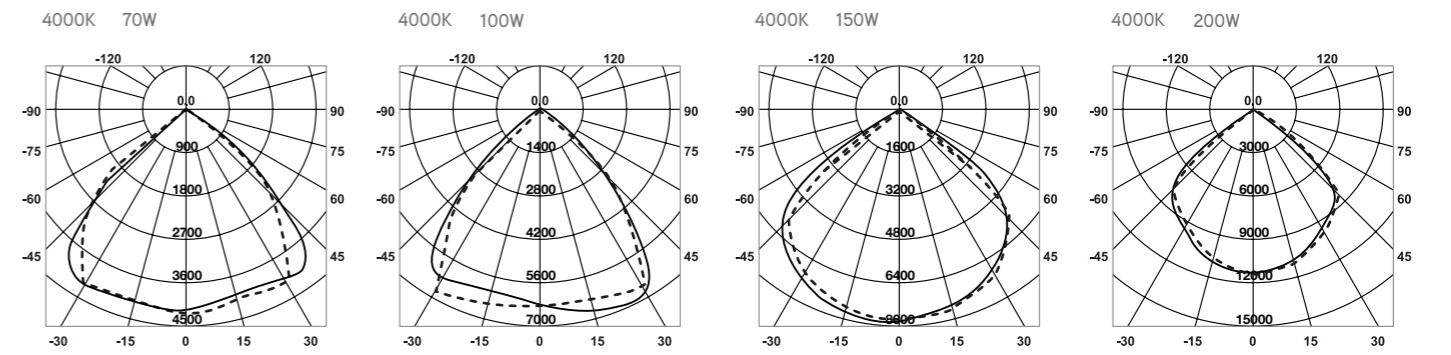

| | | | | | |
|-------|--------|---------|---------|--------|--------|
| 2,0m | 330cm | 1055 lx | 1590 lx | 312 lx | 439 lx |
| 4,0m | 660cm | 264 lx | 398 lx | 78 lx | 110 lx |
| 6,0m | 990cm | 117 lx | 177 lx | 35 lx | 49 lx |
| 8,0m | 1320cm | 66 lx | 99 lx | 20 lx | 27 lx |
| 10,0m | 1660cm | 42 lx | 64 lx | 12 lx | 18 lx |

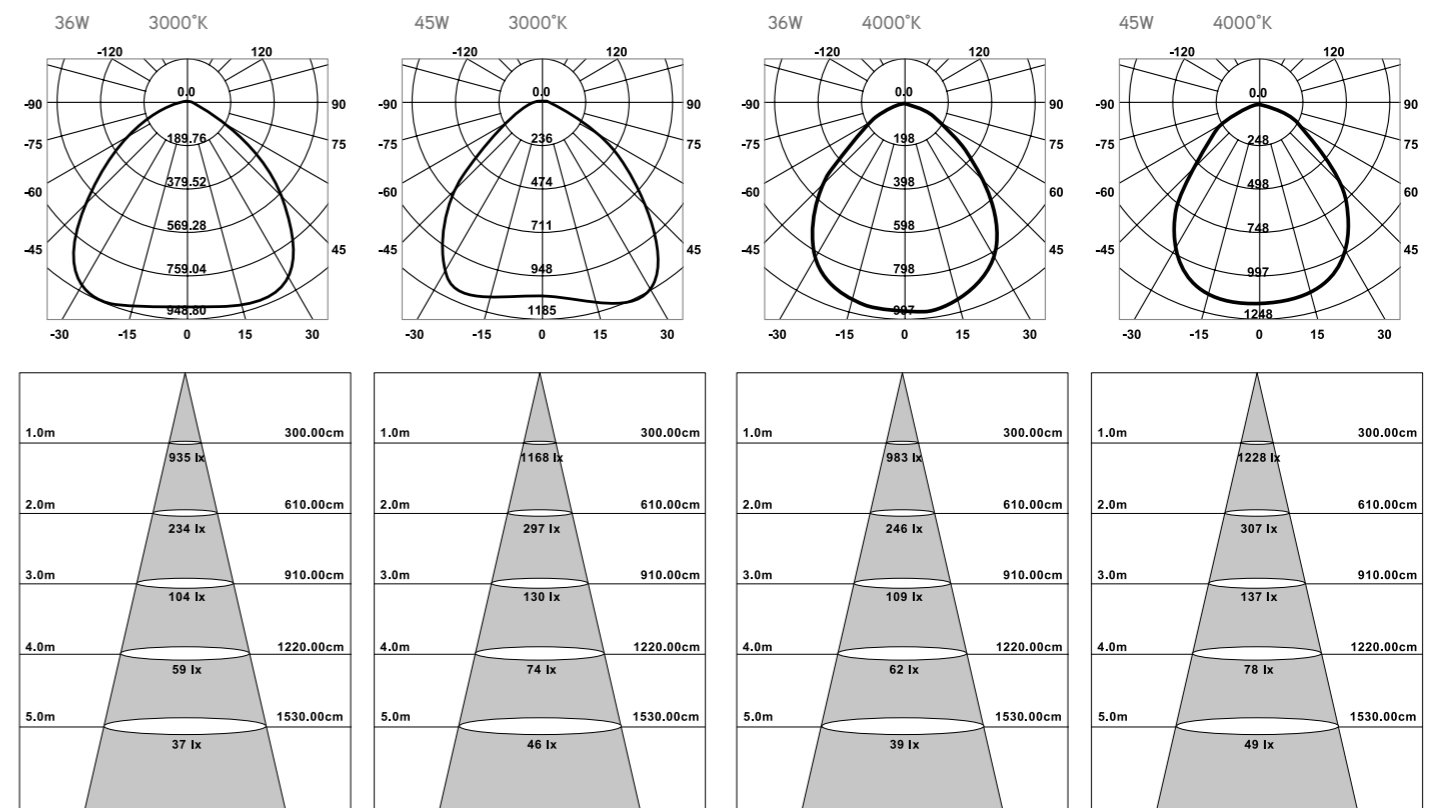
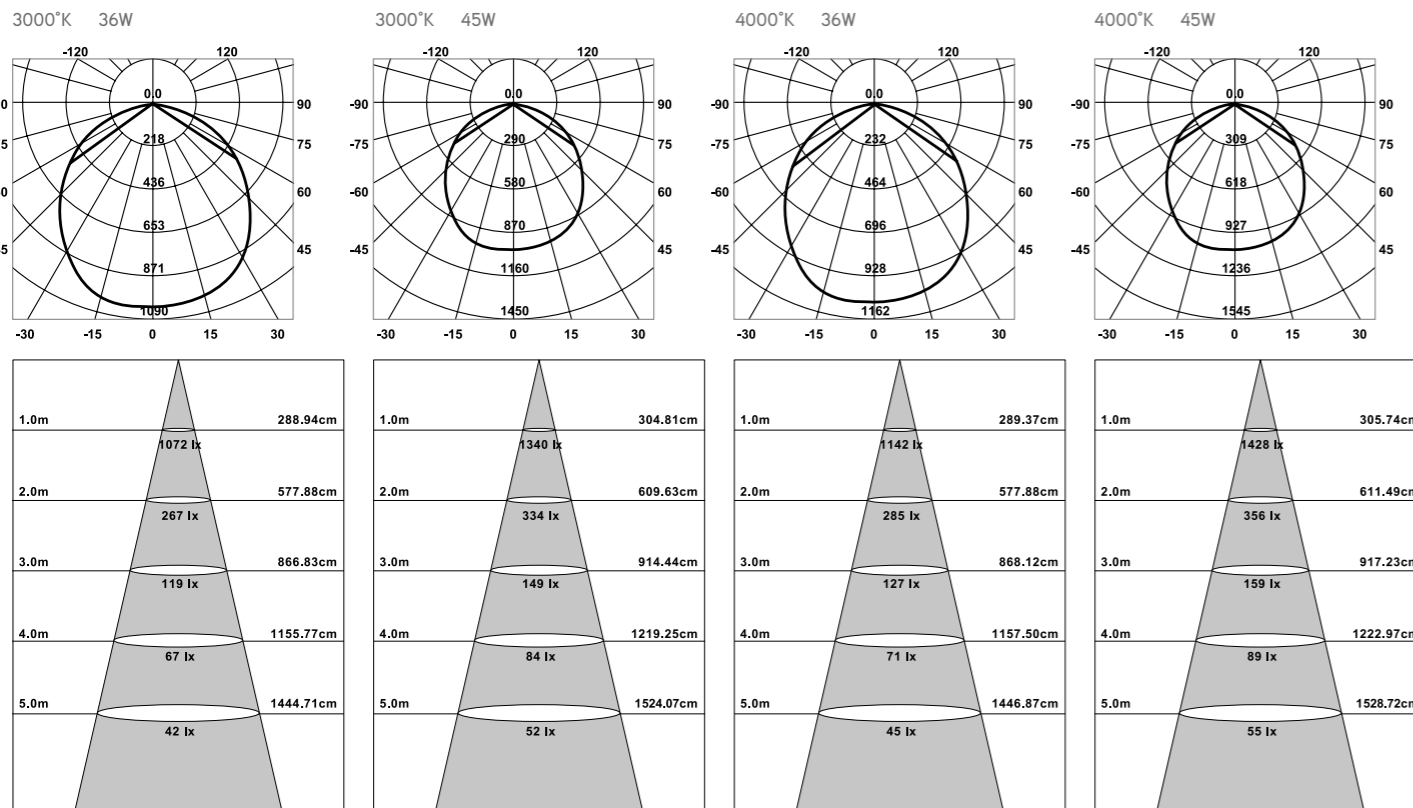
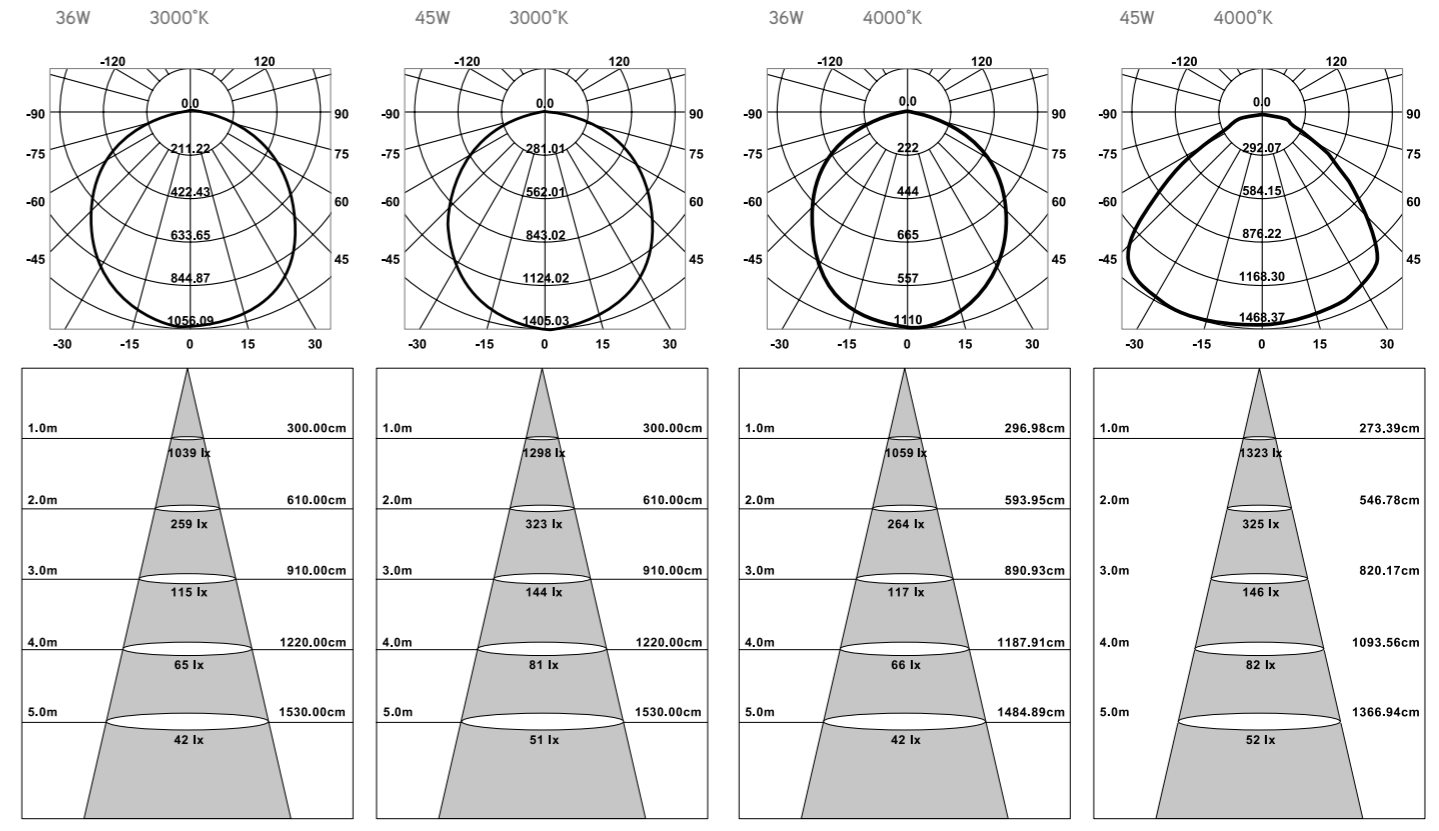
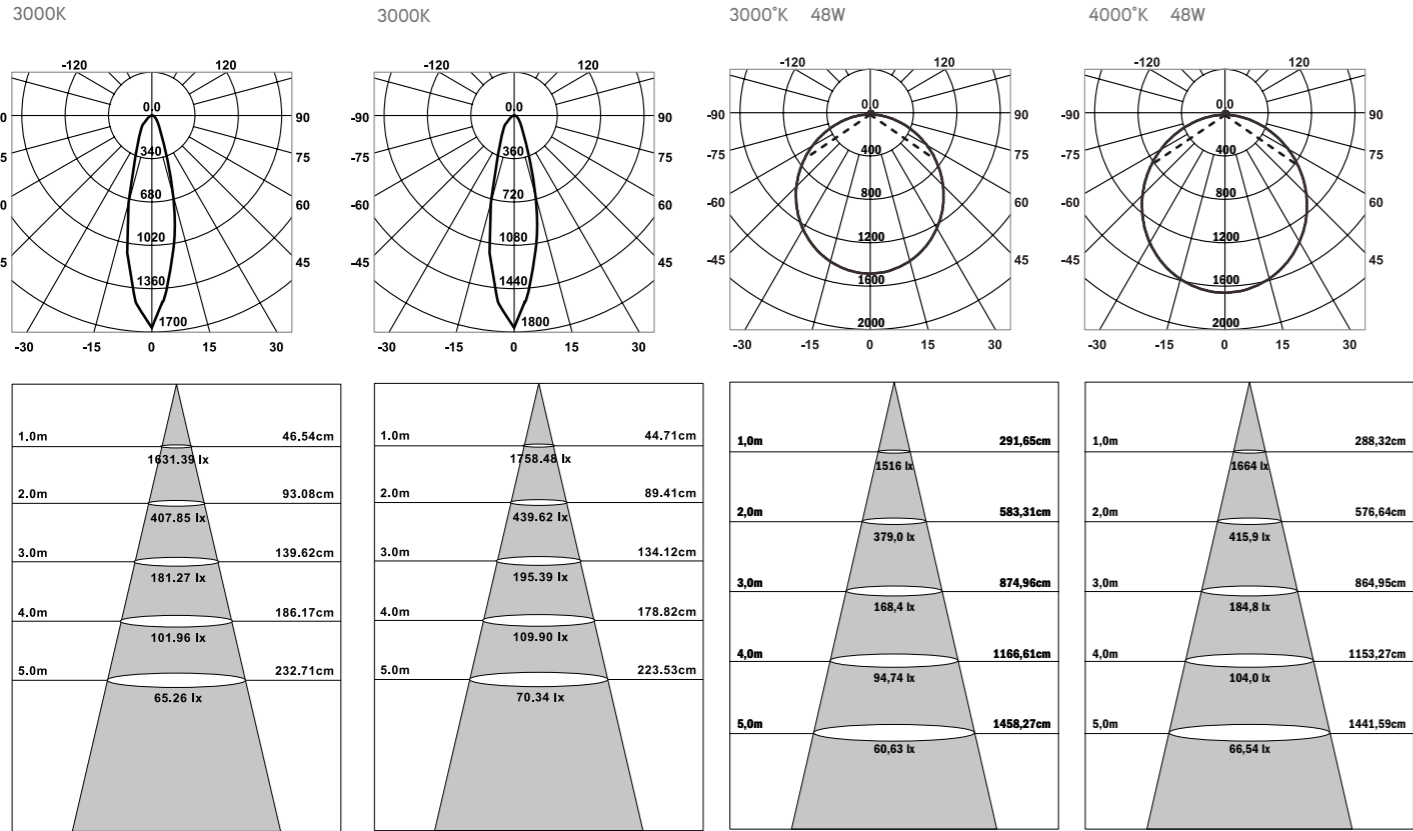

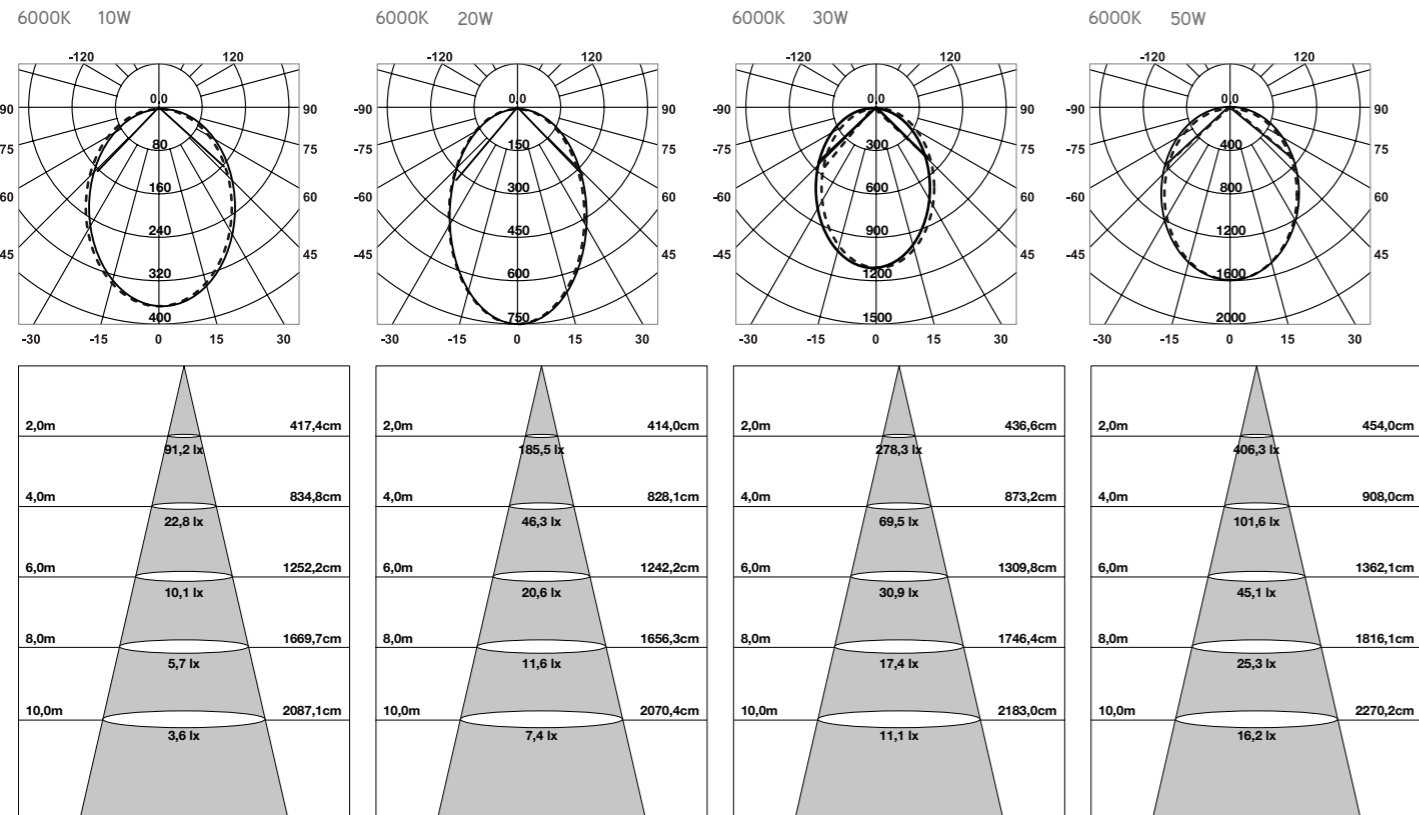
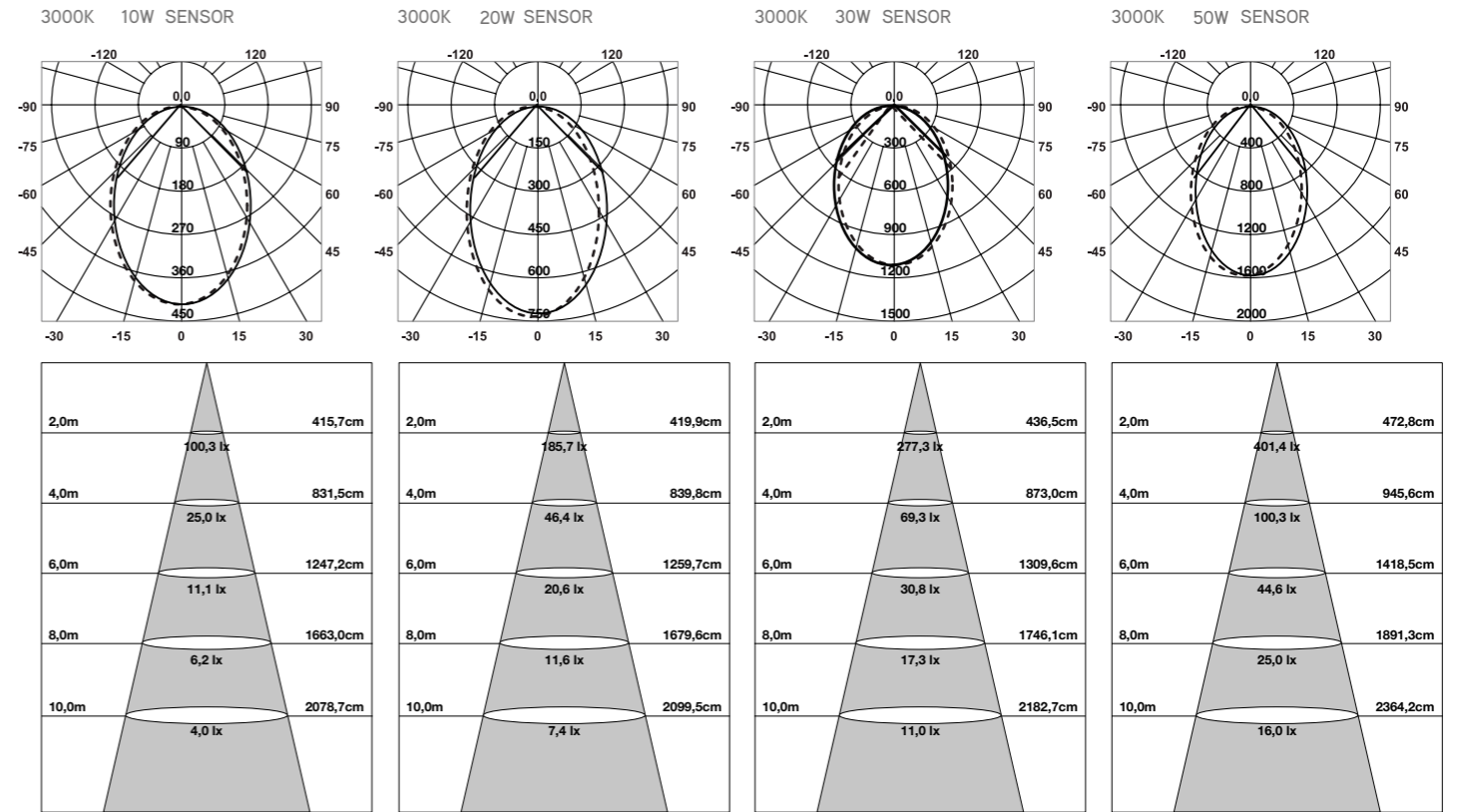
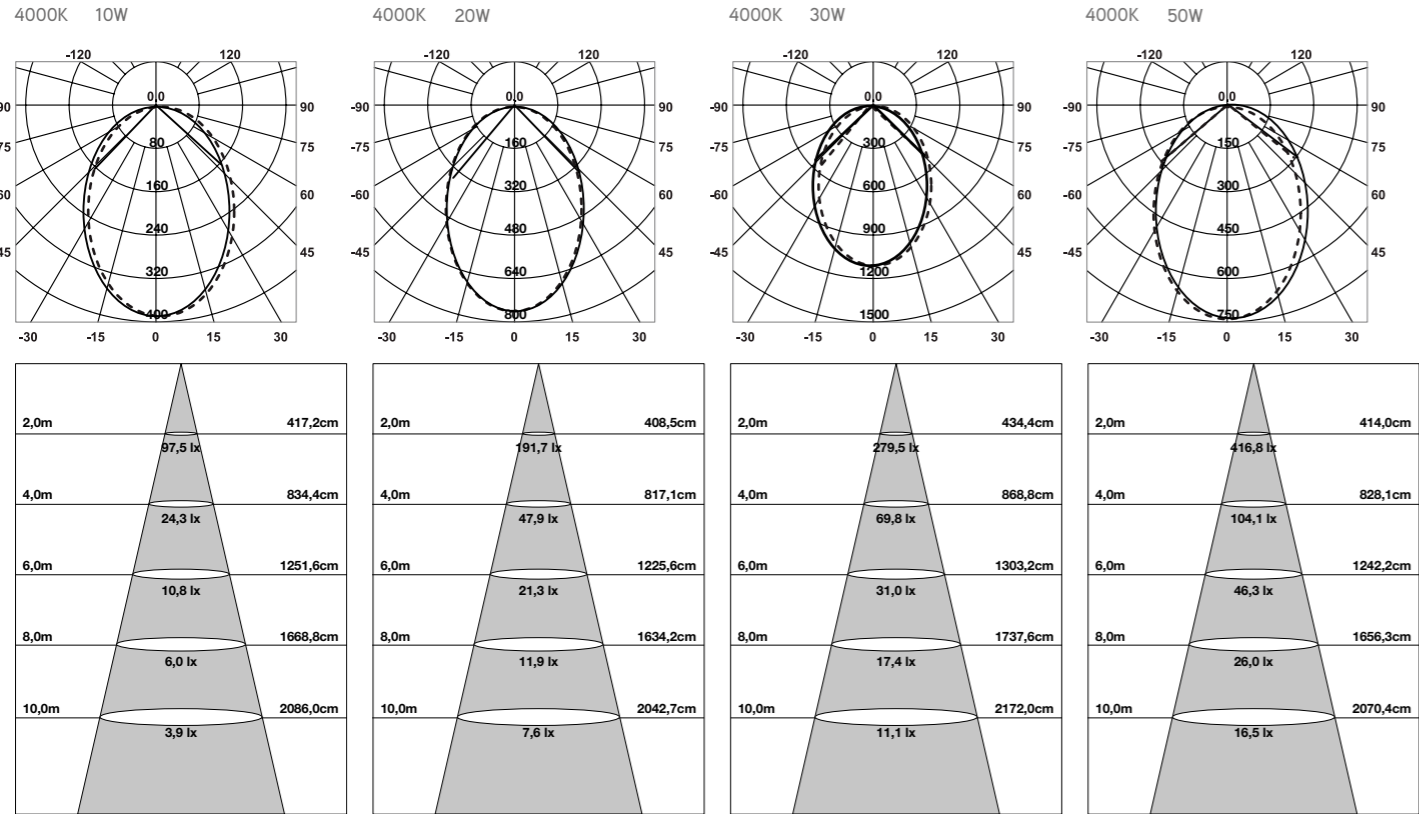

LISTINO IVA ESCLUSA - ECO-FEE INCLUSO

| Codice | € | Pag | Codice | € | Pag | Codice | € | Pag |
|---------|--------|-------|--------|--------|-----|--------|-------|-----|
| 11622/2 | 18,90 | 22-24 | 40306 | 31,14 | 63 | 40515 | 36,30 | 6 |
| 11622/3 | 30,90 | 25 | 40322 | 78,00 | 73 | 40516 | 36,30 | 6 |
| 12549 | 112,00 | 22-25 | 40323 | 61,95 | 66 | 40517 | 38,94 | 6 |
| 12550 | 169,00 | 22-25 | 40324 | 61,95 | 67 | 40518 | 38,94 | 6 |
| 12835 | 95,00 | 22-25 | 40326 | 11,34 | 15 | 40540 | 15,30 | 59 |
| 21340 | 8,54 | 51 | 40327 | 12,43 | 15 | 40541 | 24,90 | 59 |
| 21341 | 12,51 | 51 | 40348 | 65,78 | 69 | 40542 | 33,60 | 59 |
| 21342 | 15,56 | 51 | 40365 | 15,75 | 36 | 40543 | 55,92 | 59 |
| 21343 | 8,54 | 51 | 40366 | 15,75 | 36 | 40544 | 15,30 | 59 |
| 21344 | 12,51 | 51 | 40378 | 139,36 | 31 | 40545 | 24,90 | 59 |
| 21345 | 15,56 | 51 | 40388 | 4,10 | 16 | 40546 | 33,60 | 59 |
| 21918 | 11,00 | 82 | 40389 | 4,10 | 16 | 40547 | 55,92 | 59 |
| 22918 | 32,90 | 82 | 40390 | 5,36 | 16 | 40548 | 26,10 | 59 |
| 40015 | 7,25 | 76-77 | 40391 | 5,36 | 16 | 40549 | 36,60 | 59 |
| 40016 | 11,87 | 76-77 | 40392 | 5,36 | 16 | 40550 | 45,72 | 59 |
| 40154 | 44,63 | 68 | 40395 | 6,72 | 17 | 40551 | 69,00 | 59 |
| 40155 | 72,98 | 68 | 40396 | 4,41 | 17 | 40552 | 9,90 | 57 |
| 40157 | 41,48 | 76 | 40397 | 4,41 | 17 | 40553 | 15,00 | 57 |
| 40182 | 93,45 | 72 | 40398 | 6,72 | 17 | 40554 | 24,60 | 57 |
| 40205 | 34,65 | 71 | 40399 | 6,72 | 17 | 40555 | 33,60 | 57 |
| 40206 | 34,65 | 71 | 40431 | 23,40 | 40 | 40556 | 9,90 | 57 |
| 40210 | 32,44 | 12 | 40432 | 42,60 | 40 | 40557 | 15,00 | 57 |
| 40211 | 32,44 | 13 | 40433 | 53,40 | 40 | 40558 | 24,60 | 57 |
| 40222 | 112,00 | 22 | 40439 | 28,49 | 32 | 40559 | 33,60 | 57 |
| 40223 | 112,00 | 22 | 40440 | 41,89 | 32 | 40560 | 9,90 | 57 |
| 40224 | 118,00 | 22 | 40441 | 39,07 | 33 | 40561 | 15,00 | 57 |
| 40225 | 118,00 | 22 | 40442 | 59,43 | 33 | 40562 | 24,60 | 57 |
| 40232 | 136,50 | 64 | 40443 | 79,70 | 23 | 40563 | 33,60 | 57 |
| 40234 | 136,50 | 64 | 40444 | 86,00 | 23 | 40564 | 15,30 | 59 |
| 40243 | 136,50 | 65 | 40445 | 79,70 | 23 | 40565 | 24,90 | 59 |
| 40245 | 136,50 | 65 | 40446 | 86,00 | 23 | 40566 | 33,60 | 59 |
| 40284 | 22,50 | 42 | 40447 | 94,50 | 24 | 40567 | 55,92 | 59 |
| 40285 | 24,60 | 42 | 40448 | 100,50 | 24 | 40568 | 60,00 | 57 |
| 40286 | 27,60 | 42 | 40449 | 94,50 | 24 | 40569 | 60,00 | 57 |
| 40287 | 22,50 | 42 | 40450 | 100,50 | 24 | 40570 | 60,00 | 57 |
| 40288 | 24,60 | 42 | 40482 | 2,42 | 16 | 40571 | 24,20 | 8 |
| 40289 | 27,60 | 42 | 40511 | 18,90 | 6 | 40572 | 32,70 | 8 |
| 40303 | 25,80 | 62 | 40512 | 18,90 | 6 | 40573 | 41,70 | 8 |
| 40304 | 31,14 | 62 | 40513 | 29,88 | 6 | 40574 | 45,20 | 8 |
| 40305 | 25,80 | 63 | 40514 | 29,88 | 6 | 40575 | 24,20 | 8 |

LISTINO IVA ESCLUSA - ECO-FEE INCLUSO

| Codice | € | Pag | Codice | € | Pag | Codice | € | Pag |
|--------|--------|-----|--------|--------|-------|--------|--------|-----|
| 40576 | 32,70 | 8 | 41568 | 597,00 | 48 | 42566 | 28,26 | 45 |
| 40577 | 41,70 | 8 | 41569 | 597,00 | 48 | 42567 | 46,26 | 45 |
| 40578 | 45,20 | 8 | 41570 | 597,00 | 48 | 42568 | 46,26 | 45 |
| 40752 | 43,30 | 10 | 41571 | 82,00 | 25 | 42569 | 46,26 | 45 |
| 40753 | 43,30 | 10 | 41572 | 86,50 | 25 | 42576 | 89,00 | 60 |
| 40829 | 22,20 | 55 | 41585 | 156,00 | 28 | 42577 | 89,00 | 60 |
| 40830 | 30,60 | 55 | 41586 | 156,00 | 28 | 42578 | 89,00 | 60 |
| 40831 | 43,20 | 55 | 41595 | 158,00 | 29 | 42609 | 109,00 | 39 |
| 40832 | 76,20 | 55 | 41596 | 158,00 | 29 | 42610 | 129,00 | 39 |
| 40833 | 109,20 | 55 | 42034 | 44,52 | 70 | 42611 | 149,00 | 39 |
| 40834 | 150,00 | 55 | 42043 | 44,52 | 70 | 42612 | 109,00 | 38 |
| 40835 | 234,00 | 55 | 42535 | 41,48 | 77 | 42613 | 129,00 | 38 |
| 40836 | 288,00 | 55 | 42536 | 44,10 | 78 | 42614 | 149,00 | 38 |
| 40837 | 22,20 | 55 | 42538 | 42,00 | 22-24 | 43439 | 28,49 | 32 |
| 40838 | 30,60 | 55 | 42539 | 22,80 | 22-24 | 43440 | 41,40 | 32 |
| 40839 | 43,20 | 55 | 42540 | 28,80 | 25 | 43441 | 39,07 | 33 |
| 40840 | 76,20 | 55 | 42541 | 44,10 | 78 | 43442 | 58,10 | 33 |
| 40841 | 109,20 | 55 | 42543 | 16,08 | 41 | 43544 | 34,37 | 34 |
| 40842 | 150,00 | 55 | 42544 | 16,08 | 41 | 43545 | 46,88 | 34 |
| 40843 | 234,00 | 55 | 42545 | 16,08 | 41 | 45598 | 33,60 | 74 |
| 40844 | 288,00 | 55 | 42546 | 20,04 | 41 | 45599 | 44,63 | 74 |
| 41504 | 41,80 | 80 | 42547 | 20,04 | 41 | 45600 | 31,40 | 75 |
| 41505 | 49,45 | 80 | 42548 | 20,04 | 41 | 45601 | 31,40 | 75 |
| 41506 | 42,70 | 81 | 42549 | 23,28 | 41 | 45608 | 33,60 | 74 |
| 41507 | 53,25 | 81 | 42550 | 23,28 | 41 | 45609 | 44,63 | 74 |
| 41544 | 34,59 | 34 | 42551 | 23,28 | 41 | 45610 | 31,40 | 75 |
| 41545 | 48,04 | 34 | 42552 | 29,34 | 41 | 45611 | 31,40 | 75 |
| 41555 | 17,36 | 50 | 42553 | 29,34 | 41 | | | |
| 41556 | 23,56 | 50 | 42554 | 29,34 | 41 | | | |
| 41557 | 35,96 | 50 | 42555 | 13,86 | 44 | | | |
| 41558 | 21,70 | 50 | 42556 | 13,86 | 44 | | | |
| 41559 | 29,76 | 50 | 42557 | 13,86 | 44 | | | |
| 41560 | 39,65 | 50 | 42558 | 19,68 | 44 | | | |
| 41561 | 82,00 | 25 | 42559 | 19,68 | 44 | | | |
| 41562 | 86,50 | 25 | 42560 | 19,68 | 44 | | | |
| 41563 | 474,00 | 48 | 42561 | 24,06 | 44 | | | |
| 41564 | 474,00 | 48 | 42562 | 24,06 | 44 | | | |
| 41565 | 474,00 | 48 | 42563 | 24,06 | 44 | | | |
| 41566 | 474,00 | 48 | 42564 | 28,26 | 45 | | | |
| 41567 | 597,00 | 48 | 42565 | 28,26 | 45 | | | |



Marino Cristal S.p.A.

Via Guardia del Consiglio 29

47899 Serravalle - Rep. di San Marino

Tel. (+378) 0549-901188

Fax (+378) 0549-900612

www.marinocristal.com

email: marinocristal@marinocristal.com

Project: Asolana Group

Prepress: Asolana Group

Photo: Laurent Bernardi

Asolana Group

Paolo Berto

Print: Asolana Group

01-2018

asolanagroup.com

I nostri prodotti sono soggetti a continui sviluppi e cambiamenti. Ci riserviamo il diritto di mutare le specifiche o eliminare alcuni modelli senza preavviso. I colori stampati in questo catalogo non possono produrre fedelmente le tinte dei nostri prodotti. Pertanto sono da considerarsi puramente indicativi. È vietata la riproduzione, anche parziale, di questo catalogo in qualsiasi forma e su qualsiasi supporto senza autorizzazione.

Our products are subjected to continuous changes and developments. We reserve the right to modify the specification or eliminate some models without notice. The colours printed in this catalogue may not reproduce faithfully the hues of the products and have to be considered merely indicative. Total or partial reproduction of this catalogue in any form is not allowed without our prior consent.



marinocrystal.com