



# LAMPO\_EVO\_CCT

**Ω HOME GA**  
ILLUMINAZIONE

Black LED Floodlight  
Die-cast aluminium body  
Frosted glass diffuser  
Built-in driver.

Code	41932
Finishing	Nero - Black
Beam	120 °
Watt	50
Colour temperature	3000/4000/6000 °K
Volt	220-240V
Hz	50/60Hz Hz
Lumen	4250/4500/4350
<span style="line-height: 18.9091px;">CRI</span>	>80
Power factor	>0,9
Length	180x130x35 mm
Isolation class	Cl.1
IP Protection	IP65
Dimensions	220x155x19 mm
IK	08
Weight	0.435 Kg
Pack	20

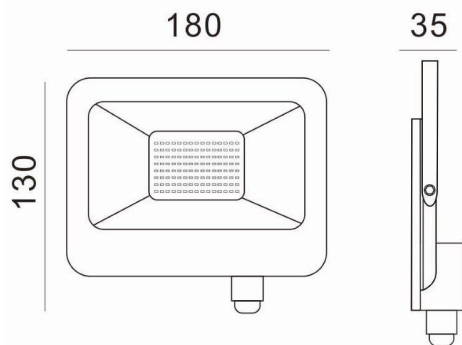

Via Guardia del Consiglio, 29 - 47899 Serravalle - Rep. San Marino  
Tel. +378 0549 901188 - Fax +378 0549 900612  
marinocristal@marinocristal.com - www.marinocristal.com